

**JTS**<sup>®</sup>

## US-8001D(DB)/US-8002D(DB)/US-8216D Series

**JTS**<sup>®</sup> PROFESSIONAL CO., LTD.

No. 148, 9th Industry Road, Ta-Li Industrial Park,  
Taichung City, Taiwan, R.O.C.

Tel: 886-4-24938803 Fax: 886-4-24914890

E-mail: [jts@jts.com.tw](mailto:jts@jts.com.tw)

[www.jts.com.tw](http://www.jts.com.tw)





US-8002D(DB)

US-8001D(DB)

**US-8216D Series**

**Instruction Manual**

Thank you for choosing the JTS wireless system. In order to obtain the best efficiency from the system, you are recommended to take a few minutes to read this instruction manual carefully.

# INDEX

1. Important Caution	1
2. Features	1
3. Specification	2
3-1 Receiver// US-8001D(DB)/ US-8002D(DB)/US-8216D	2
3-2 Handheld Transmitter // Mh-750 / Mh-850 / Mh-8016	2
3-3 Miniature Head Worn Transmitter/UT-16HW	3
3-4 Body-pack Transmitter // PT-850B(mi)	3
3-5 Optional Condenser Microphone	4
4. Part Identification & Accessories	6
4-1 Receiver// US-8001D(DB)/ US-8002D(DB)/US-8216D	6
4-2 Handheld Transmitter // Mh-750 / Mh-850 / Mh-8016	6
4-3 Miniature Head Worn Transmitter/UT-16HW	7
4-4 Body-pack Transmitter // PT-850B(mi)	7
4-5 Optional Condenser Microphone	7
4-6 Accessories	11
5. Preparing Procedures & Basic Operation	12
5-1 Receiver// US-8001D(DB)/ US-8002D(DB)/US-8216D	12
5-2 Rack Mounting	13
5-3 Battery Insertion of the transmitter	14
5-4 Body-pack Transmitter // PT-850B(mi)	15
6. System operation	16
7. Recommendation	19
8. Important notice	20

# 1. Important Caution

- Always makes all connections before plugging the unit into an AC power outlet.
- Do not leave the device in a place neither with high temperature nor high humidity.
- Always do not handle the power cord with wet hands!
- Keep the devices away from fire and heat sources.

# 2. Features

- Operated in UHF band where there is less RF interference than the VHF band.
- Due to the PLL synthesized technology, the system offer 16 selectable channel.
- The true diversity reception with 2 independent RF receivers ensure the stable transmission and reception.
- Adjustable squelch control can effectively reduce the noise.
- Tuned antennas can benefit the stable RF reception.
- Built-in T one key Squelch & Noise Mute detection are available to restrain the interference signal.
- Rugged metal housing can pass through the difficult environment.
- Equipped with balanced XLR and unbalanced output allows great convenience.
- Body-pack transmitter provides phantom powering for condenser lavalier and headset microphones.

# 3. Specification

## 3-1 Receiver

Model No .....	US-8001D(DB)/US-8002D(DB)/US-8216D
Frequency Preparation.....	PLL Synthesized Control
Carrier Frequency Range.....	502~960 MHz
S/N Ratio.....	> 105dB
T.H.D.....	<0.6%@1KHz
Display.....	LED
Display Contents.....	Antenna A/B, RF/AF Status
Controls.....	Power On/Off, Channel Selecting, Audio Level
Audio Output Level.....	-12dB
AF Output Impedance.....	600Ω
Squelch.....	Pilot Tone, Noise and Mute
Operation Voltage.....	US-8002D(DB)/US-8216D: 12-18 VDC, 200mA US-8001D(DB): 12-18 VDC, 150mA
Output Connector.....	1 Balanced XLR socket (2 for US-8002D(DB)/US-8216D) 1 Unbalanced Ø6.3mm phone jack
Dimension(m/m).....	221mm (W)* 40mm (H)* 152mm (D)

## 3-2 Handheld Transmitter

Model No.....	Mh-750 / Mh-850	Mh-8016(i)
Frequency Preparation.....	PLL Synthesized Control	PLL Synthesized Control
Carrier Frequency Range....	502~960 MHz	502~960 MHz
RF Outputs.....	10mW	10mW
Stability.....	±10KHz	±10KHz
Frequency Deviaion.....	±48KHz	±48KHz
LED Display.....	Low Battery, Power On/Off	
Controls.....	Power On/Off, Channel Selecting	Power On/Off, Channel Up/Down
Spurious Emissions.....	<-50 dBC	<-60 dBC
Audio Frequency Resonse	50~16,000 Hz	50~16,000 Hz
Battery.....	UM3, AA 1.5V*2	UM3, AA 1.5V*2

### 3-3 Miniature Head Worn Transmitter

Model No.....	UT-16HW
Frequency Preparation.....	PLL Synthesized Control
Carrier Frequency Range.....	502~960 MHz
RF Outputs.....	Maximum 10mW
Stability.....	±10KHz
Frequency Deviation.....	±48KHz
LED Display.....	Power On/Off, Low battery
Controls.....	Power On/Off, AF Level, Channel Selecting, Mute
Spurious Emissions.....	<-50 dBC
Audio Frequency Response	40~18,000 Hz
Battery.....	LR03, AAA 1.5V

### 3-4 Body-pack Transmitter

Model No.....	PT-850B(mi)
Frequency Preparation.....	PLL Synthesized Control
Carrier Frequency Range.....	502~960 MHz
RF Outputs.....	10mW
Stability.....	±10KHz
Frequency Deviation.....	±48KHz
LED Display.....	Power On/Off, Low battery
Controls.....	Power On/Off, AF Level, Channel Selecting
Spurious Emissions.....	<-50 dBC
Audio Frequency Response	40~18,000 Hz
Battery.....	UM3, AA 1.5V*2

### 3-5 Optional Condenser Microphone

#### Lavaliere Microphone

Model No.....	CM-501	CM-201i	CM-125i
Connector.....	4P Mini XLR	4P Mini XLR	4P Mini XLR
Frequency Response.....	100~15,000 Hz	60~15,000 Hz	50~18,000 Hz
Polar Pattern.....	Cardioid	Omni-directional	Omni-directional
Sensitivity (at 1000Hz)	-60±3 dB	-60±3 dB	-53±3 dB
Impedance.....	2.2kΩ	2.2kΩ	4.4kΩ
Max. SPL for 1% THD	130dB	130dB	130dB
Dimension(mm).....	Ø10.1mm(W) * 26.4mm(H)	Ø5mm(W) * 9mm(H)	Ø4mm(W) * 11mm(H)
Net Weight.....	21.5g	20.7g	7g (cable excluded)

#### Headset Microphone

Model No.....	CM-214i	CM-214Ui	CM-214ULi
Connector.....	801C4 (4P Mini XLR)	4P Mini XLR	801C3 (3P Mini XLR) 801C4 (4P Mini XLR) 801CS (3.5 stereo plug)
Option Connector.....	801C3 (3P Mini XLR) 801CS (3.5 stereo plug) 801CR		801CR
Frequency Response.....	60~15,000 Hz	30~18,000 Hz	100 ~ 18,000Hz
Polar Pattern.....	Omni-directional	Cardioid	Cardioid
Sensitivity (at 1000Hz)	-60±3 dB	-68±3 dB	-65±3 dB
Impedance.....	1.8kΩ	680Ω	1.8kΩ
Max. SPL for 1% THD	130dB	130dB	120dB
Dimension(mm).....	125mm(W) * 134mm(H) * 157mm(D)	205mm(W) * 134mm(H) * 157mm(D)	125mm(W) * 134mm(H) * 157mm(D)
Net Weight.....	32.9g	38.4g	18g (cable excluded)
Model No.....	CM-235i	CX-504	
Connector.....	801C4 (4P Mini XLR)	4P Mini XLR	
Frequency Response.....	50~18,000 Hz	30~18,000 Hz	
Polar Pattern.....	Omni-directional	Cardioid	
Sensitivity (at 1000Hz)	-53±3 dB	-68±3 dB	
Impedance.....	1.8kΩ	680Ω	
Max. SPL for 1% THD	130dB	130dB	
Dimension(mm).....	155mm(W) * 134mm(H) * 157mm(D)	285mm(W) * 55mm(H) * 111.3mm(D)	
Net Weight.....	17g (cable excluded)	56.3g	



## Ear-hook Microphone

Model No.....	CM-801/CM-804i	CM-8015/CM-825i
Connector.....	801C4 (4 pin mini XLR)	801C4 (4 pin mini XLR)
Option Connector.....	801C3 (3 pin mini XLR)	801C3 (3 pin mini XLR)
	801CS (3.5 stereo plug)	801CS (3.5 stereo plug)
	801CR	801CR
Frequency Response.....	60~15,000 Hz	50~18,000 Hz
Polar Pattern.....	Omni-directional	Omni-directional
Sensitivity (at 1000Hz)	-64±3 dB	-53±3 dB
Impedance.....	1.8kΩ	1.2kΩ
Max. SPL for 1% THD	130dB	130dB

## Compatible Instrument Microphone

Model No.....	CX-500	CX-500F	CX-520
Connector.....	4P Mini XLR	4P Mini XLR	4P Mini XLR
Frequency Response.....	20~20,000 Hz	50~18,000 Hz	50~18,000 Hz
Polar Pattern.....	Omni-directional	Omni-directional	Supercardioid
Sensitivity (at 1000Hz)	-58±3dB	-58±3dB	-78±3dB
Impedance.....	1.5kΩ	1.5kΩ	600Ω
Max. SPL for 1% THD	130 dB	130 dB	148 dB
Good For.....	Violin	Flutes	Harmonica

Model No.....	CX-508W	CX-516W
Connector.....	4P Mini XLR	4P Mini XLR
Frequency Response.....	50~18,000 Hz	50~18,000 Hz
Polar Pattern.....	Cardioid	Cardioid
Sensitivity (at 1000Hz)	-67±3 dB	-67±3 dB
Impedance.....	220Ω	220Ω
Max. SPL for 1% THD	130 dB	130 dB
Good For.....	Winds	Accordion

# 4. Parts Identification & Accessories

## 4-1 Receiver // US-8001D(DB) / US-8002D(DB)/US-8216D

- ① Power On
- ② Channel Selector
- ③ RF indicator
- ④ AF indicator
- ⑤ Volume control
- ⑥ Antenna(BNC Antenna for US-8001DB, US-8002DB)
- ⑦ DCV Input (US-8002D(DB)/US-8216D 12-18V DC/200mA)  
(US-8001D(DB) 12-18V DC/150mA)
- ⑧ Unbalanced 6.3mm jack socket
- ⑨ Balanced XLR socket

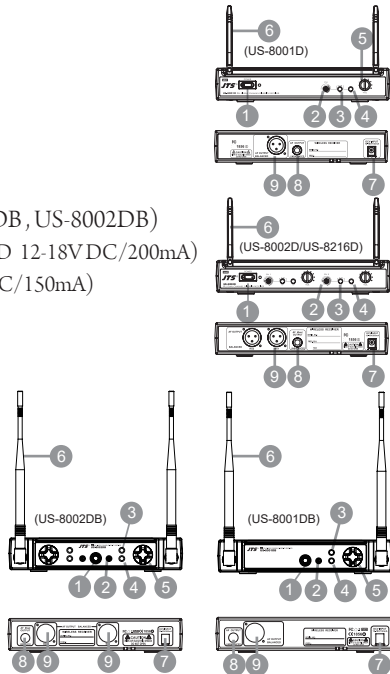

## 4-2 Handheld Transmitter // Mh-850/Mh-750/Mh-8016( i )

- ⑩ Interchangeable capsule module
- ⑪ Battery tray release knobs
- ⑫ Battery tray
- ⑬ Channel selector
- ⑭ Power On/Off switch
- ⑮ LED Indicator
- ⑯ ID housing
- ⑰ Gain control

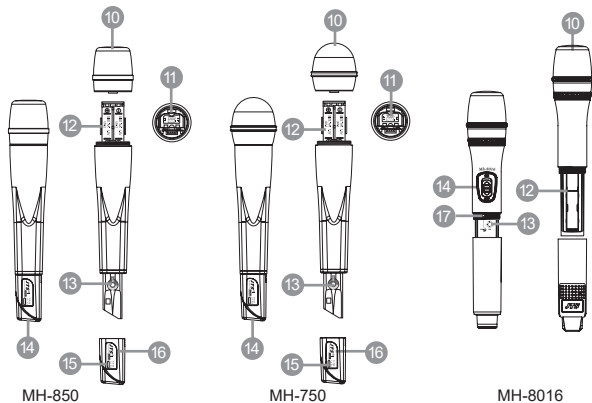

### 4-3 Miniature Head Worn Transmitter//UT-16HW

- 18 Gooseneck
- 19 Headband
- 20 Battery Lid (Color ID): Orang/White/Gray
- 21 Adjustable elastic headband
- 22 Input gain
- 23 Channel selector
- 24 Power On/Mute/Off switch
- 25 LED indicator for power On/Off, battery status and mute
- 26 Sweat Shield

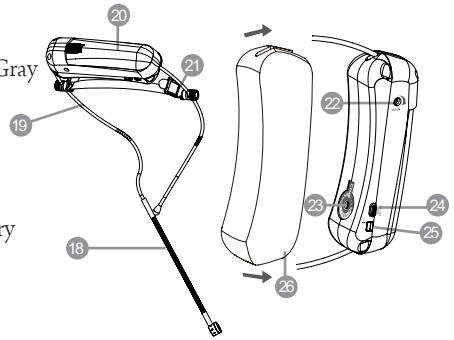

### 4-4 Body-pack Transmitter // PT-850B(mi)

- 27 Mic. input (4 pin mini XLR socket)
- 28 Power On/Off switch
- 29 Antenna
- 30 LED indiccator for power and battery status
- 31 Battery tray
- 32 AF level control
- 33 Belt-loop
- 34 Carry case
- 35 Channel selector

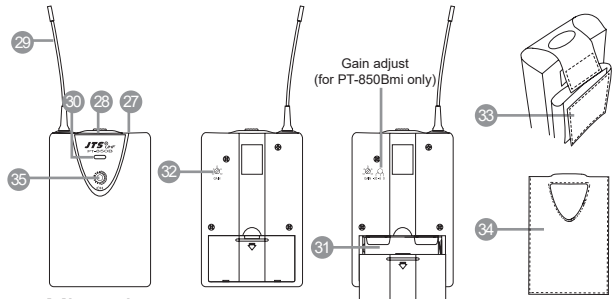

### 4-5 Optional Condenser Microphone

#### Lavaliere Microphone // CM-501 / CM-201i / CM-125i

- 36 Clip
- 37 4 Pin Mini XLR
- 38 Windscreen

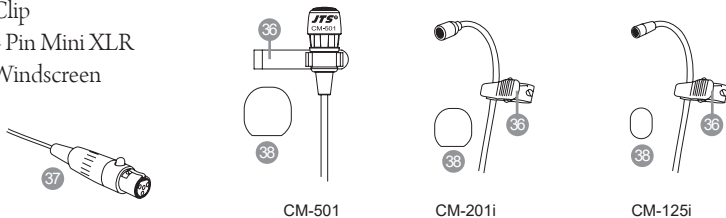

# Headset Microphone // CM-214i / CM-214Ui / CM-214ULi / CM-235i / CX-504

- 39 Gooseneck
- 40 Adjustable headband
- 41 Headband
- 42 4 Pin Mini XLR
- 43 Windscreen

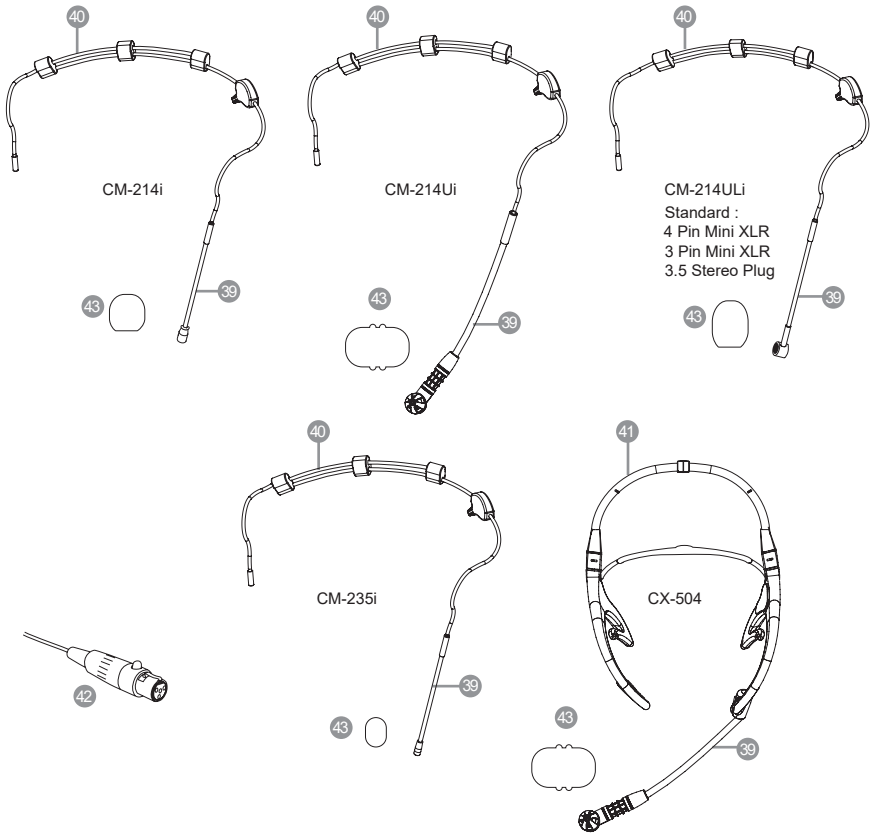

## Ear-hook Microphone // CM-801 / CM-804i / CM-8015 / CM-825i

- 44 Boom
- 45 Adjustable Headband
- 46 Adjustable ear hook
- 47 Detchable Cable
- 48 Cable Clip
- 49 Windscreen
- 50 4 Pin Mini XLR
- 51 3 Pin Mini XLR Option
- 52 3.5 Stereo Plug Option
- 53 4Pin Hirose connector Option

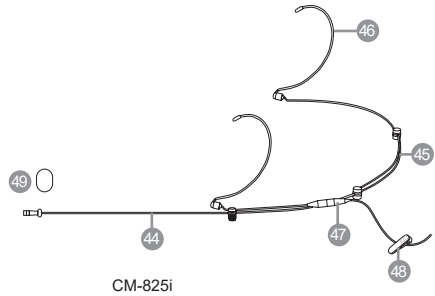
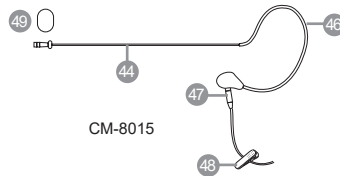
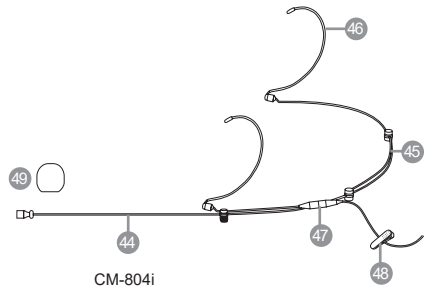
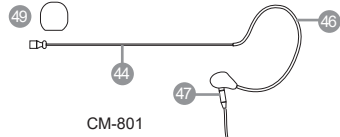
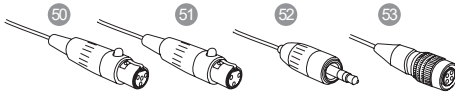

Compatible Instrument Microphone // CX-500 / CX-500F / CX-520 /  
CX-508W / CX-516W

- 54 Gooseneck
- 55 Clip
- 56 Bracket
- 57 Volume Control
- 58 Windscreen
- 59 4-Pin Mini XLR

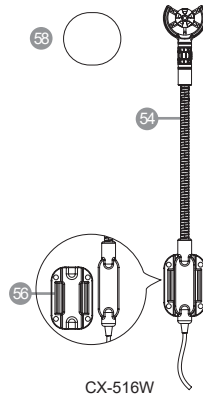
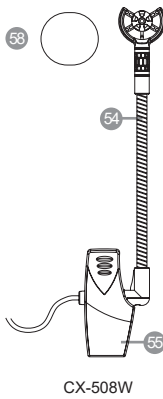
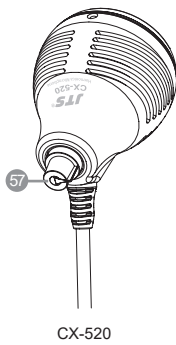
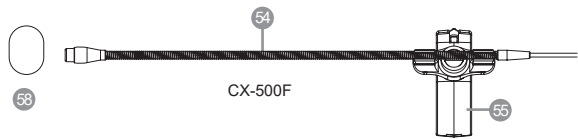
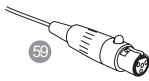
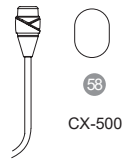

## 4-6 Accessories

- 60 AC/DC adaptor
  - A Switching Power Supply (100V~240V, 50~60Hz)
  - B Linear Power Supply (220V, 50Hz) **Option**
  - C Linear Power Supply (220V, 60Hz) **Option**
- 61 Screwdriver
- 62 DR-900 Dual Rack Adaptor **Option**
- 63 RP-900 Panel Cover **Option**
- 64 AF output cable (with Ø6.3 plug at both ends)
- 65 GC-80/GC-100 Guitar Cable **Option**
- 66 GC-80L/GC-100L Guitar Cable **Option**

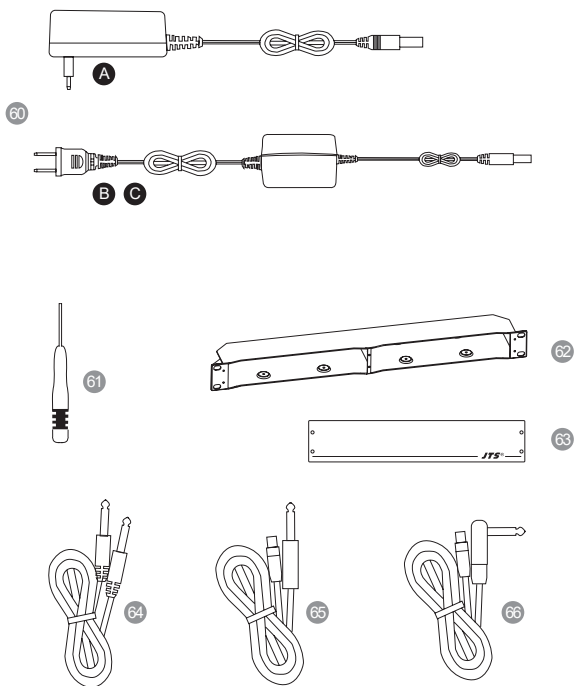

# 5. Preparing Procedures & Basic Operation

## 5-1 Receiver // US-8001D(DB) / US-8002D(DB)/US-8216D

### (1) Audio Output Connector

The receiver equipped with both balanced XLR output and unbalanced  $\phi$  6.3mm jack output; you can choose the proper way for using.

Connect one end of the Audio cable to the AF output socket in the rear panel of the receiver and plug another end to the "MIC IN" input socket of a mixer or amplifier. (Step 1 of Figure 1)

### (2) Power connection

Connect one end of AC/DC adaptor cable to DC input socket in the rear panel of the receiver, and plug another end into an AC outlet. (Step 2 of Figure 1)

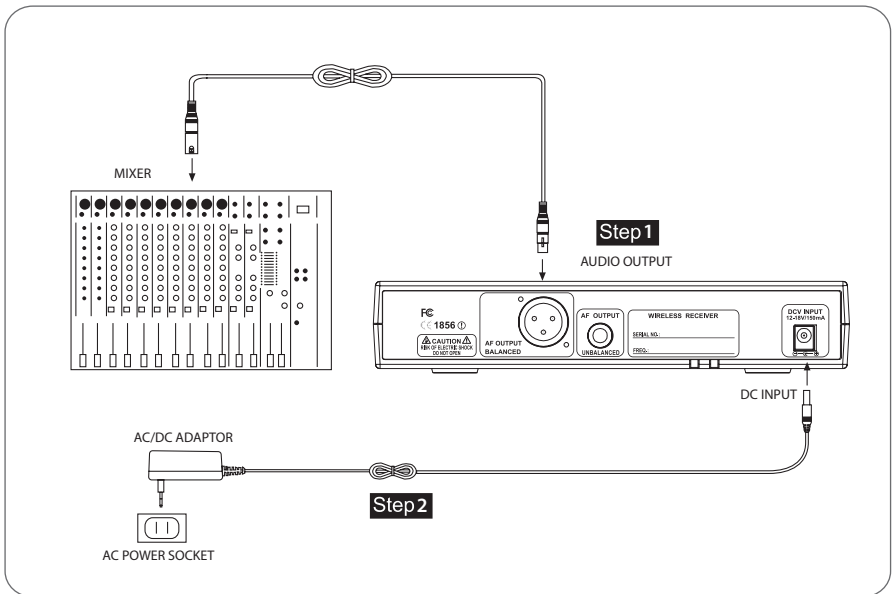



## 5-2 Rack Mounting

- (1) Before mount receivers onto DR-900 rack adaptor, please release any cables from the rear of the receiver.
- (2) Turn over receiver and DR-900 rack adaptor simultaneously, there are 4 threaded holes each in the bottom of receiver and rack adaptor for inserting screws.
- (3) Single receiver  
Insert a receiver through the front of DR-900 until it is firmly attached to the rack, then screw on a RP-900 to another side of the rack. (Figure 4)
- (4) Dual receivers  
The same way as above, put one receiver to each rack space.

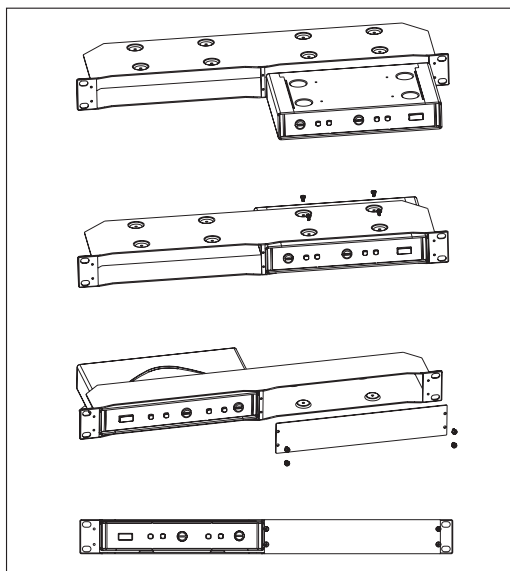

(Figure 4)

## 5-3 Battery Insertion of the transmitter

### (1) Mh-850 & Mh-750 Handheld Transmitter

1. Turn the microphone ball grille counter-clockwise (Figure 1), press both release knobs to remove the battery tray from the mic. housing (Figure 2).
2. Insert two 1.5V batteries according to the correct polarity (Step 1 of Figure 3) and return the battery tray back to housing (Step 2 of Figure 3).  
Aim the connecting pins exactly toward the cavities on the bottom side of detachable mic. capsule module (Figure 4) and tighten it clockwise!

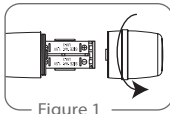

Figure 1

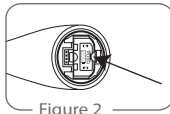

Figure 2

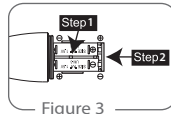

Figure 3

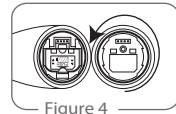
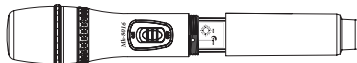
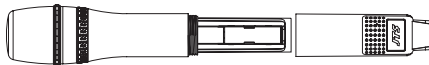

Figure 4

### (2) Mh-8016 Series Handheld Transmitter

1. Insert 2 pcs 1.5V AA batteries into the battery tray.
2. After putting into the battery, switch on the power switch.



## 5-4 Body-pack Transmitter // PT-850B(mi)

- (1) Slide the battery tray cover in the direction of the arrow to open it. Insert two 1.5V batteries according to the correct polarity, and return the cover.

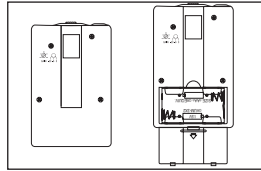

- (2) Lavalier microphone

Attach lavalier microphone to a tie, lapel, where is suitable for sound pick-up. Plug the connector into input socket on the body-pack transmitter.

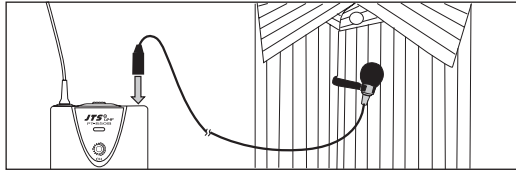

- (3) Headset microphone

Put the headband behind your head, and fix the temples on your ears as shows, then adjust the gooseneck to have best miking. Plug the connector into input socket on the body-pack transmitter.

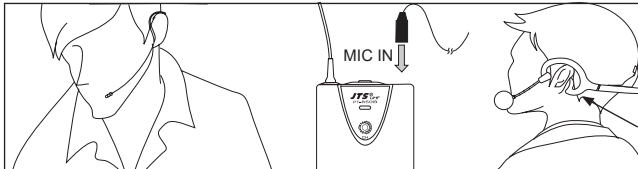

- (4) Instrument Microphones

The system is compatible with JTS various instrument microphones. For detail please refer to user's manuals of these microphones.

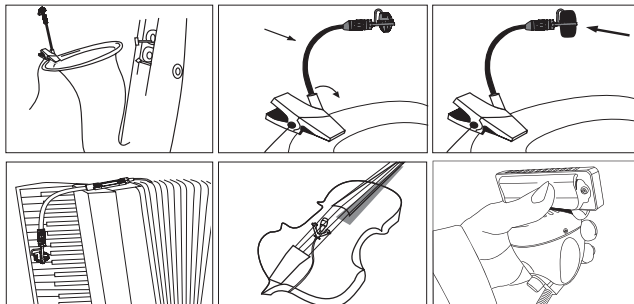

## 6. System operation

Be sure to mute the audio signal of a mixer or amplifier before turning on the receiver and transmitter.

### (1) Power on

Turn AF level on the receiver completely counter-clockwise to the minimum level, and switch on the receiver. As soon as you turn power of the receiver on, the power LED lights red, meanwhile the RF signal and AF LED light up to indicate the receiver is ready for operating.

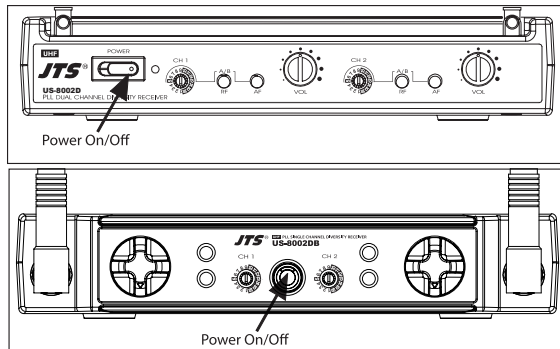

Always it's a good idea to keep "open space" between transmitter and receiver, that will improve RF reception.

### (2) Selecting channel for the receiver and transmitter

1. Use the supplied screwdriver to select a desired channel for the receiver and transmitters. Both receiver and transmitters are preprogrammed with 16 channels.

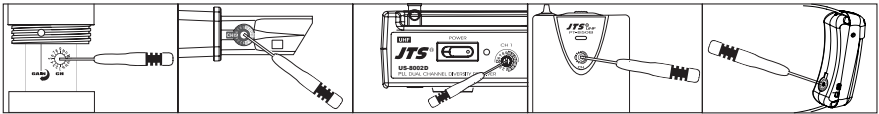

2. Make sure the channel of receiver matches that of the transmitter.
3. When 2 or more transmitters and receivers are being used in the same location, they must be set up to use different channels. If existing channel is being interfered, please change to another non-interference channel.

(3) Using the PT-850B / PT-850Bmi Body-pack transmitter

1. Use the supplied screwdriver to adjust the gain control on the rear panel of PT-850B / PT-850Bmi body-pack transmitter to a proper level.

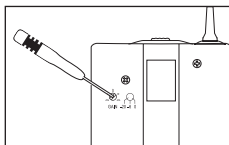

2. The carry case allows the PT-850B to be attached on performer's belt, place the antenna towards the back of his body. The Velcro tag ensures tight fixing and less hindrance during performance.

Wing the Velcro tag around the belt and fix it.

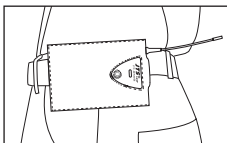
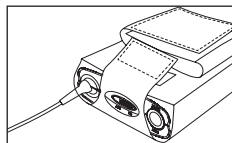

## (6) Ear-hook Microphone

### 1. Lightweight Dual Ear Hook Microphone

Try on whether the headset is fit.

Adjust the headband to a suitable width.

Tighten or loosen the curve of the ear-hook by twisting the loop or expanding it.

Curve and bend the boom to fit your face.

Attach the detachable cable to a suitable place by a cable clip.

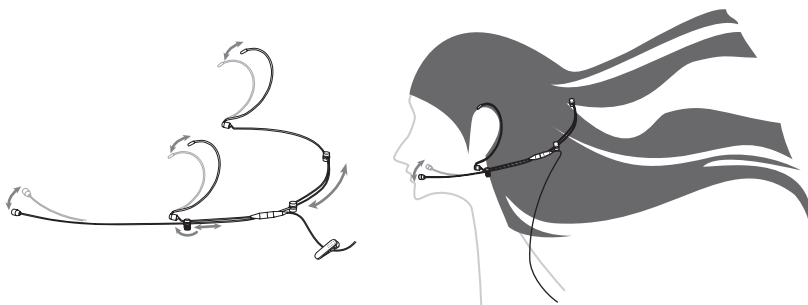

### 2. Lightweight Single Ear Hook Microphone

Try on whether the original curve is tight or loose.

Re-try and push the fixed curve against your earlobe.

Curve and Bend the boom to fit your face.

Attach the detachable cable to a suitable place by a cable clip.

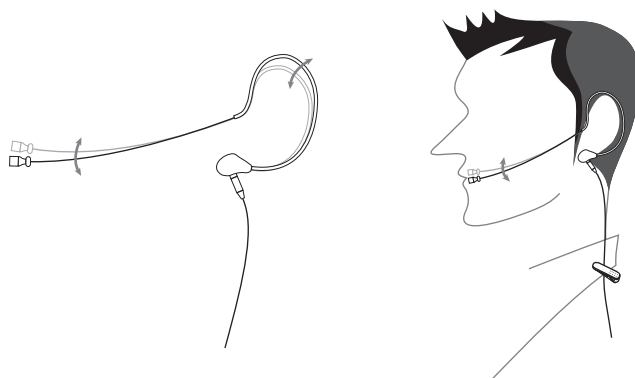

## 7. Recommendation

- (1) In order to achieve the optimum reception condition and also extend the operating distance, please leave a “open space” between the receiver and transmitter.
- (2) Keep the devices away from the metal objects or any interference sources, at least 50 cm.
- (3) To avoid the feed-back effect, don't leave the mic. to aim at the speakers directly.
- (4) For best pick-up pattern, please hold the middle of the mic. body.
- (5) Remove batteries from the battery compartment when the transmitter will not be used for a long time.
- (6) When you need to replace the batteries, please replace both batteries at the same time with new ones.

## 8. Important notice

- (1) JTS offers wireless systems in a selection of bands that conform to the different government regulations of specific nations or geographic regions. These regulations help limit radio frequency (RF) interference among different wireless devices and prevent interference with local public communications channels, such as television and emergency broadcasts.
- (2) For information on bands available in your area, consult your local dealer or phone JTS. More information is also available at JTS's website ([www.jts.com.tw](http://www.jts.com.tw)).
- (3) This Radio apparatus may be capable of operating on some frequencies not authorized in your region. Please contact your national authority to obtain information on authorized frequencies and RF power levels for wireless microphone products.