



CLA 403T / CLA 803T

COLUMN LINE ARRAY



VERTICAL

IP55



EN 54-24

FBT ELETTRONICA S.p.A.
Via Paolo Soprani 1 - 62019 RECANATI (MC) - ITALY

0068/CPR/142-2020
EN 54-24:2008

Loudspeaker for voice alarm system
for fire detection and fire alarm systems for buildings

CLA 403T / CLA 803T
Type B



Dichiarazione di Prestazione (DoP) disponibile sul sito www.fbt.it
Declaration of Performance (DoP) available on the website www.fbt.it



INDICE

I	AVVERTENZE PER LA SICUREZZA	1
	DESCRIZIONE	1
	DIMENSIONI	2
	ACCESSORI	3
	MODALITÀ DI INSTALLAZIONE	4 - 5 - 6
	IMPOSTAZIONI	7
	MODALITÀ DI COLLEGAMENTO	8
	CARATTERISTICHE TECNICHE	9
STUDIO DEL SISTEMA DI SONORIZZAZIONE	10	
UK	SAFETY WARNINGS	11
	DESCRIPTION	11
	DIMENSIONS	12
	ACCESSORIES	13
	INSTALLATION MODE	14 - 15 - 16
	SETTINGS	17
	CONNECTION MODES	18
	TECHNICAL SPECIFICATIONS	19
STUDY OF THE ADDRESS SYSTEM	20	

SAFETY WARNINGS



IMPORTANT

- Loudspeaker lines (amplifier outputs) can have a sufficiently high voltage (i.e. 100 V) to involve a risk of electrocution: never install or connect this loudspeaker when the line is alive.
- Make sure all connections have been made correctly and the loudspeaker input voltage (in a constant voltage system) or its impedance is suitable for the amplifier output.
- Protect loudspeaker lines from damage; make sure they are positioned in a way that they cannot be stepped on or crushed by objects.
- Make sure that no objects or liquids can get into this product, as this may cause a short circuit.
- Use only the optional devices / accessories specified by the manufacturer.
- Also check the suitability of the support surface to which the product is anchored (wall, ceiling, structure, etc.), and the components used for attachment (screws, screw anchors, etc.).
- To prevent inductive effects from causing hum, noise and a bad system working, loudspeaker lines should not be laid together with other electric cables (mains), microphone or line level signal cables connected to amplifier inputs.
- Never attempt to carry out any operations, modifications or repairs that are not expressly described in this manual. Contact your authorized service centre or qualified personnel.
- Do not use solvents, alcohol, benzene or other volatile substances for cleaning the external parts of this product.
- La FBT ELETTRONICA SpA raccomanda che l'installazione di questo prodotto venga eseguita solamente da installatori professionali qualificati in grado di eseguirla correttamente e certificarla in accordo con le normative vigenti.
- VERTUS CLA 403T / 803T sound speakers must be installed by qualified staff only, strictly complying with the current regulations and safety standards in force in the country of installation.

DESCRIPTION

Suited to both indoor and outdoor use, the VERTUS CLA range comprises two models: CLA 803T with eight 3" full range woofers and CLA 403T with four 3" full range woofers. Both versions have the same sleek, lightweight and durable, powder-coated aluminum housing. Completely dustproof and waterproof, the enclosure's grille is covered with a special hydrophobic fabric to ensure absolute rejection of all atmospheric agents. Full EN54-24 certification also means both columns can be used for emergency and evacuation applications. Both the CLA803T and CLA403T are characterized by an integrated passive directivity control system which delivers a consistent frequency-based vertical dispersion, and which offers users the choice of two angles - NARROW and WIDE. The new functionality guarantees enormous flexibility for the integrator, even allowing for the horizontal mounting of columns. In addition VERTUS CLA enclosure is fully modular, so multiple enclosures can be linked. Other features include a 100V line transformer with switchable power levels. A wide range of accessories is also available for total system configuration flexibility.

VERTUS CLA 803T:

- Passive column array
- 8 x 3" fullrange custom woofers with 0.7" voice-coil
- Vertical dispersion angle selector: 110°H x 15°V (narrow), 110°H x 40°V (wide)
- Ceramic screw-in connector with thermal fuse
- 100V / 120W line transformer with power selector
- Extruded aluminum cabinet with powder coating
- Grille with hydrophobic fabric

VERTUS CLA 403T:

- Passive column array
- 4 x 3" fullrange custom woofers with 0.7" voice-coil
- Vertical dispersion angle selector: 110°H x 25°V (narrow), 110°H x 50°V (wide)
- Ceramic screw-in connector with thermal fuse
- 100V / 60W line transformer with power selector
- Extruded aluminum cabinet with powder coating
- Grille with hydrophobic fabric

DIMENSIONS

CLA 803T

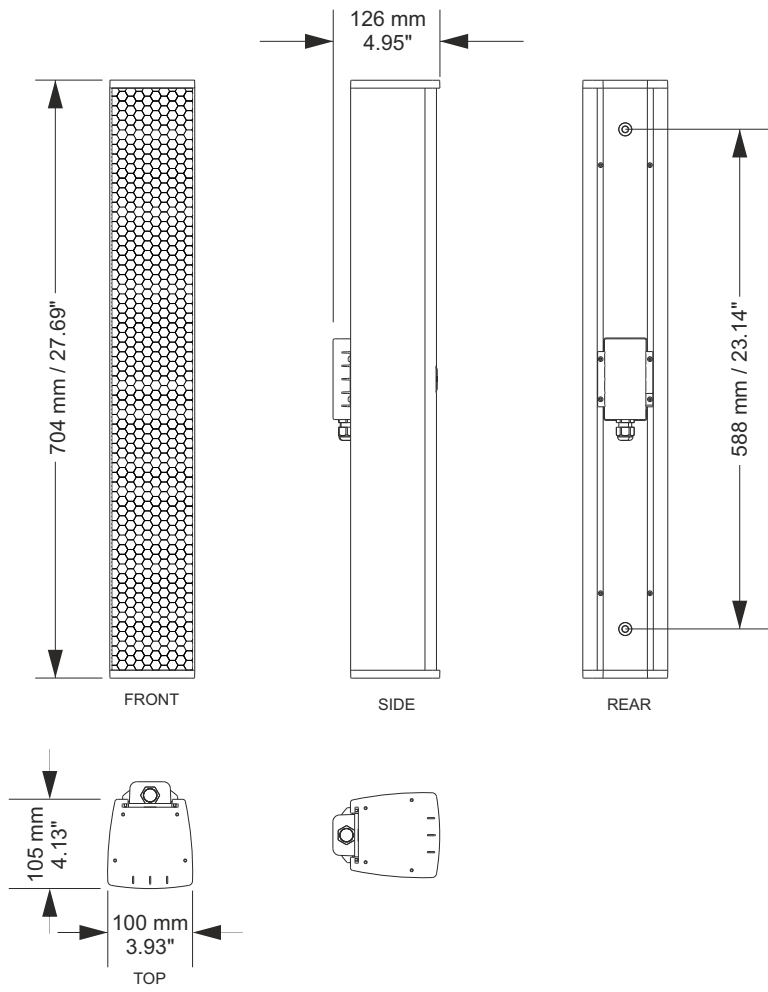

CLA 403T

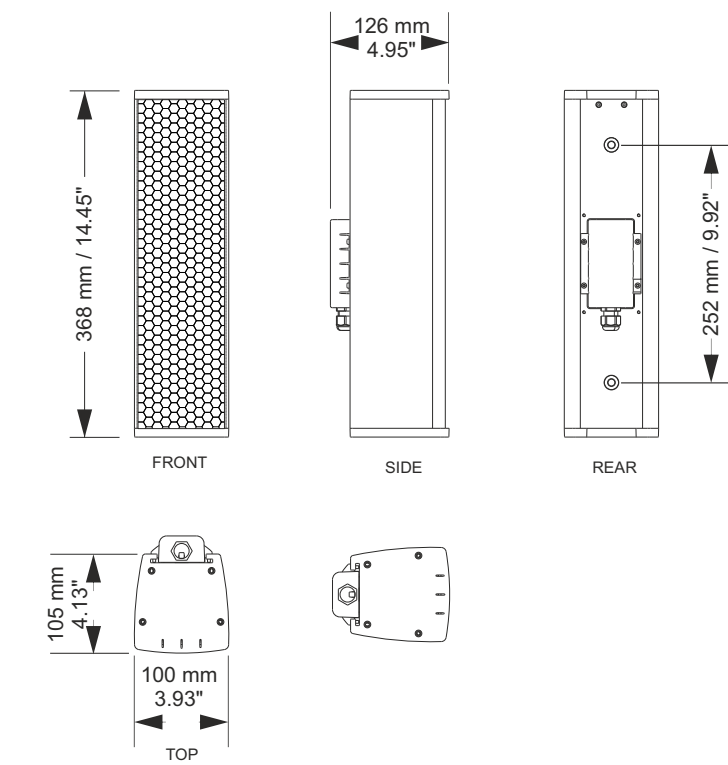

ACCESSORIES

VERTUS speakers can be installed as follows:

- Suspended in an array with flybar (with provision for clamp)
- Wall-mounted

All the speaker accessories are secured by means of a sliding rail incorporated into the back of the column, and fixing pins with spring.

CAUTION

The fixing pin is made with a LOCK/UNLOCK system that guarantees the secure coupling of the parts.

- Pull the grip and turn in an anti-clockwise direction (UNLOCK) to lift the pin.
- Turn in a clockwise direction (LOCK) to lock the connection.

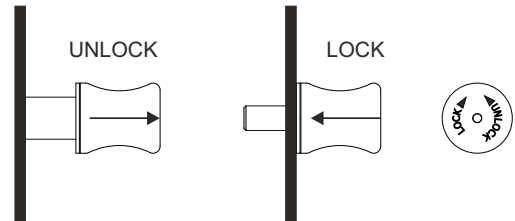

- VERTUS sound speakers must be installed using the flying accessories described in this manual and following the special assembly instructions by qualified staff only, strictly complying with the current regulations and safety standards in force in the country of installation.

- FBT flying accessories are manufactured for their exclusive use with VERTUS systems and have not been designed for being used with any other speaker or device.

- Any possible elements of the ceiling, floor or further supports where VERTUS systems are to be installed shall be able to safely bear the load.

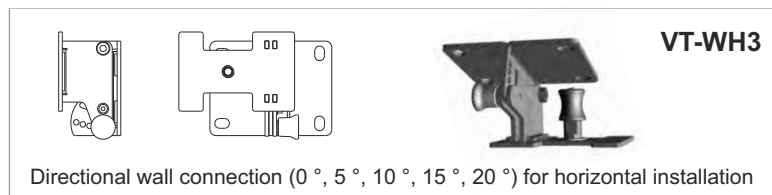

- The flying accessories in use are to be coupled and secured safely to both the sound speaker and the ceiling (or the other support). When components are fitted to ceilings, floors or beams, always make sure that all couplers and fixing elements are properly sized and have an adequate load capacity.

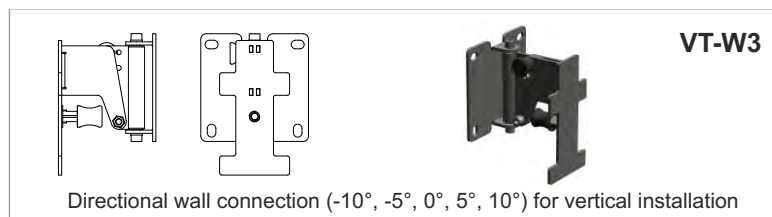

- Besides the main suspension system, all flying speakers in theatres, indoor stadiums or in several other work and/or leisure facilities shall be provided with an additional independent safety system with the adequate load capacity. Only steel cables and chains with certified load capacity can be used as an additional safety device.

THE VERTUS SPEAKERS USE ONLY WITH FBT MOUNT FOR WALL INSTALLATION. USE WITH OTHER MOUNTS IS CAPABLE OF RESULTING IN INSTABILITY CAUSING POSSIBLE INJURY.



FBT accepts no responsibility for any damage to people or objects if these instructions are not complied with or if the safety factor of all elements related to system suspension are not properly checked.

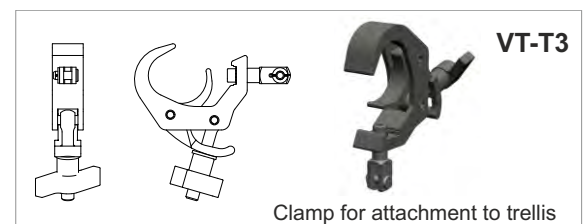
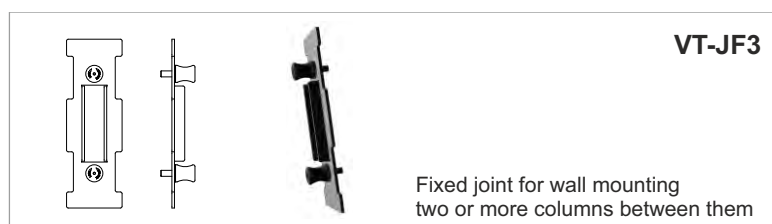

INSTALLATION MODE

LINE ARRAY

CAUTION

The suspended accessories in the VERTUS CLA403T and CLA803T series have been designed to guarantee a safety factor of 5:1.

Table (1) illustrates the net weight of the speakers and of the accessories.

The example configuration shown in the figure is composed of N.3 x CLA 803T, N. 1 flybar VT-F3, N.1 hooking clamp VT-T3, N. 2 adjustable joints VT-J3, (total weight 18.7kg / 41.22lb) inclusive of accessories.

Table (2) indicates the setting mode (NARROW or WIDE) based on the angle between the two speakers.

N.B. During installation make sure that the calculation of the overall weights for the system's load-bearing structure includes the weight of the flybar, hoist chains, motors, cables and other additional weights. Should the above safety regulations and calculation of the overall weight not to be complied with, FBT Elettronica SpA will not be liable for any damage to persons or property.

MODEL	WEIGHT	MAX LOAD
CLA 803T	5,5 kg / 12,12 lb	-----
CLA 403T	3 kg / 6,61 lb	-----
VT-F3	0,5 kg / 1,10 lb	20 kg / 44,09 lb
VT-WH3	0,7 kg / 1,54 lb	3 kg / 6,61 lb
VT-W3	0,8 kg / 1,76 lb	13 kg / 28,66 lb
VT-J3	0,6 kg / 1,32 lb	-----
VT-JF3	0,4 kg / 0,88 lb	-----
VT-T3	0,5 kg / 1,10 lb	21 kg / 46,29 lb

tab. (1)

ANGLE BETWEEN SPKR.	SETTING
0°	NARROW
5°	WIDE/NARROW
10° + 15°	WIDE

tab. (2)

HOOKING THE FLYBAR

- Position and slide flange "A" in its housing at the back of the speaker until the fixing pin "B" clicks in inside its dedicated slot.
- Position the "fixing shackle" «C» according to the desired angle of the system.
- The speaker can be hung on the lattice using the accessory "D". To be used only in combination with the flybar.
- Before each manoeuvre, always check that the shackle pin is properly tightened. Check for any faults in the positioning. Pre-tension the entire system and only after checking the regularity of each element, apply the necessary force to slowly lift the load, in a linear and constant manner, avoiding sudden jolts or braking, which due to inertia may cause dangerous swaying.

During the entire manoeuvre, the operator must be in a position allowing them to safely escape in the event of an accident, that is, they must keep a safe distance from the moving load, and the entire area must be cordoned off to unauthorised persons.

CAUTION: incorrect or improper use may cause serious injury to persons and damage to surrounding property.

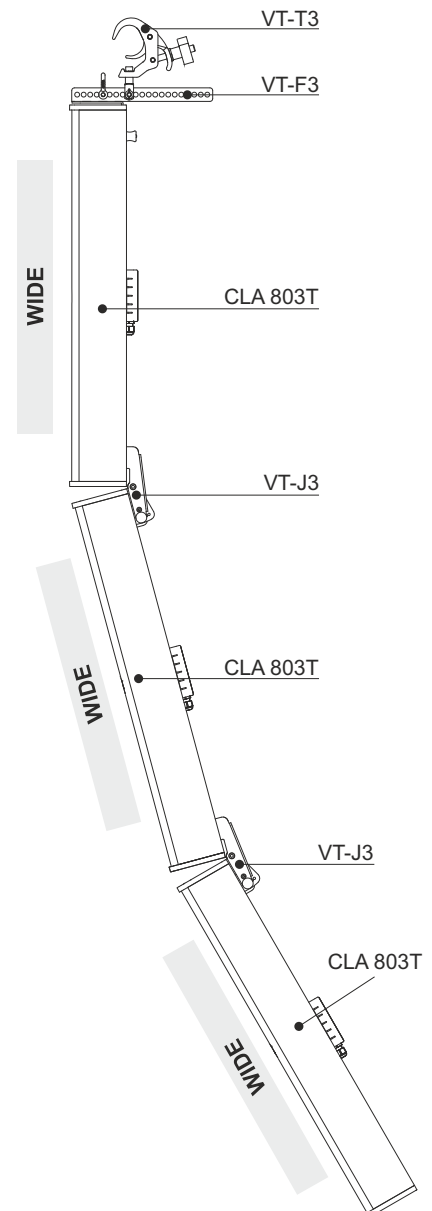
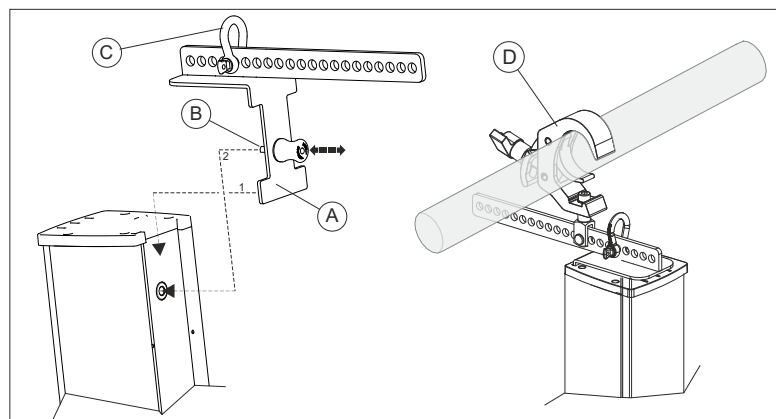

INSTALLATION MODE

WALL ARRANGEMENT

- To fix the speaker to the wall, use the adjustable wall hooks "VT-WH3" and "VT-W3" respectively to install the speaker horizontally or vertically.

VERTICAL INSTALLATION

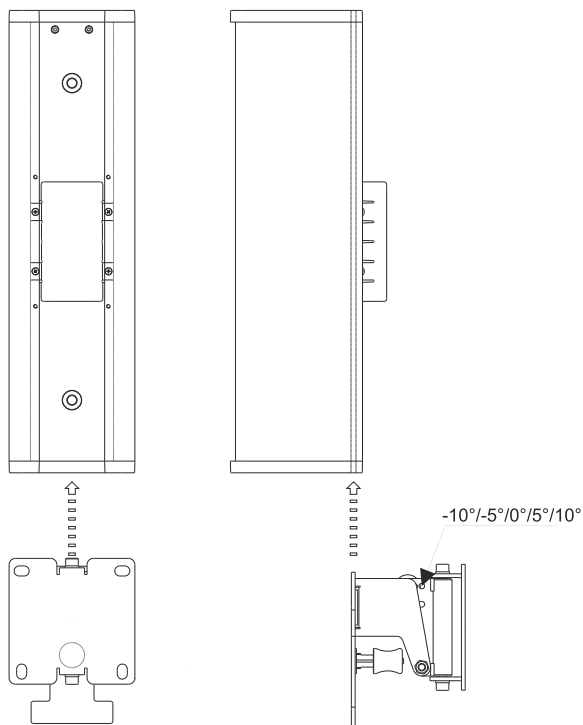
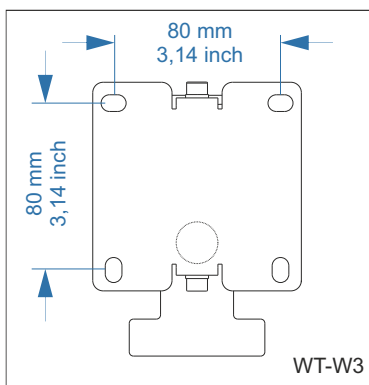

HORIZONTAL INSTALLATION

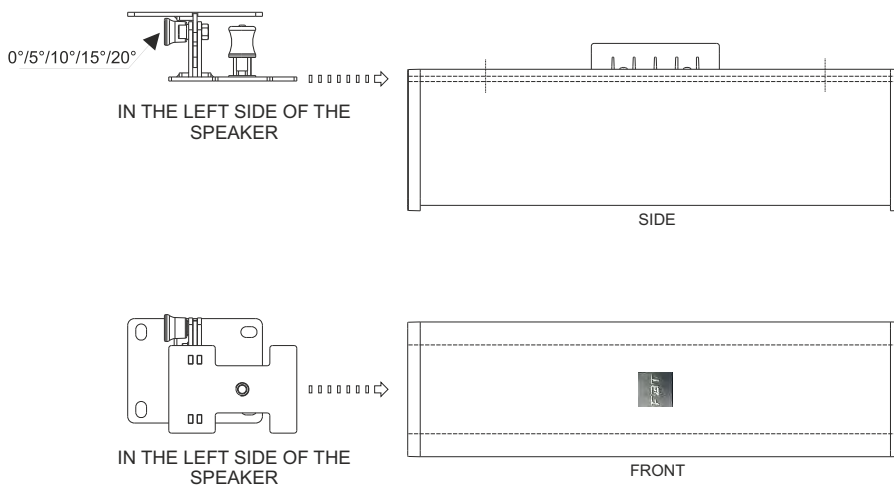
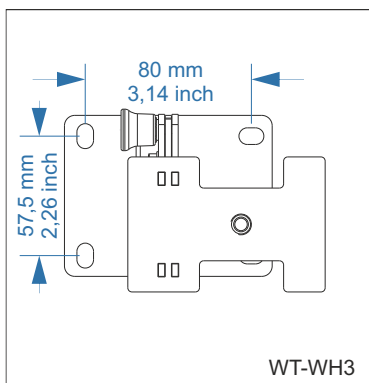

INSTALLATION MODE

WALL ARRANGEMENT

HOOK BETWEEN TWO COLUMNS

- To hook two or more columns to each other, use the fixed joint "VT-JF3" or joint "VT-J3" to create an angle between the two speakers.

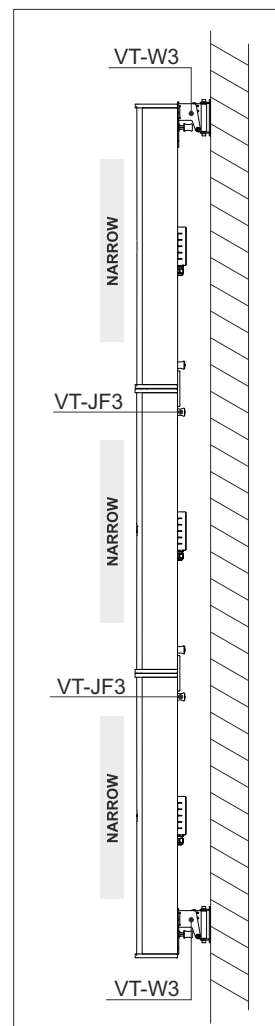
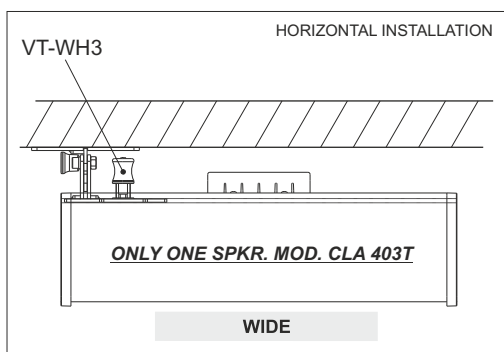
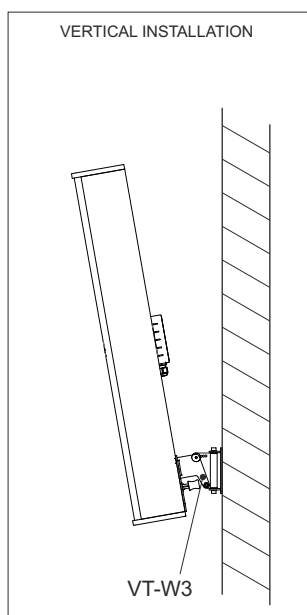
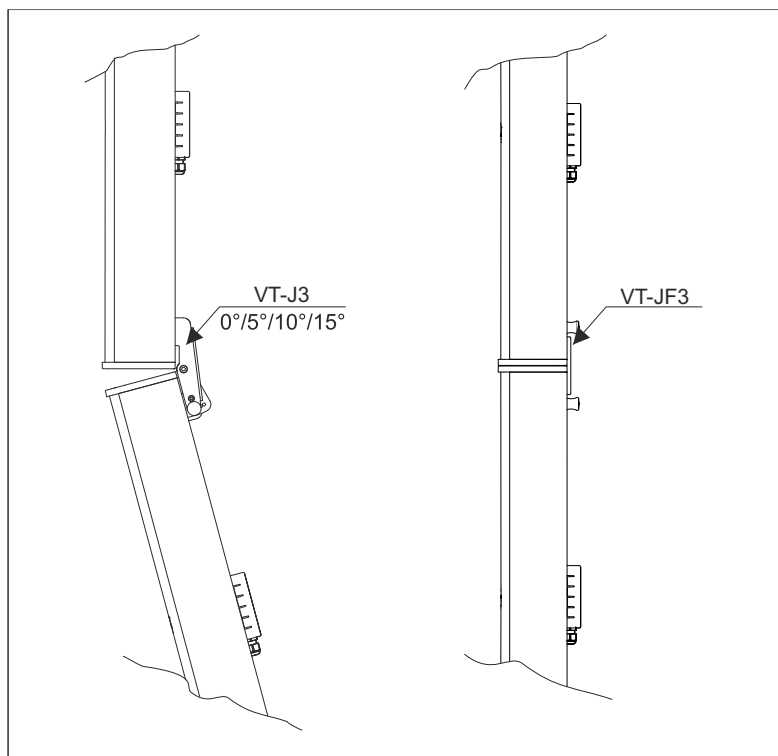

SETTINGS

REAR PANEL

Connections with the audio line are made using the ceramic clamp included in the protective casing (E).

- The two screw clamps "+" and "-" allow the connection of both the input cable and output cable for the parallel connection of other speakers. (see fig. 3)
- For 100V constant voltage lines, position the selector on the desired power value (25W, 50W for the CLA403T model) (50W, 100W for the CLA803T model).
- For the low impedance connection, position the selector on 16 Ohm for the CLA403T model and on 8 Ohm for the CLA803T model.

CAUTION: DO NOT position the selector on constant impedance when the speaker is connected in constant voltage mode (100V).

The NARROW/WIDE selector offers the possibility to choose from two different angles and also allows the columns to be horizontally mounted:

- 110°H x 15°V (narrow), 110°H x 40°V (wide) for the CLA803T model.
- 110°H x 25°V (narrow), 110°H x 50°V (wide) for the CLA403T model.

To install multiple speakers at 0° use the NARROW mode. To install the speaker horizontally, WIDE mode is recommended.

CAUTION: After making the connections and necessary adjustments, it is STRICTLY NECESSARY to reposition the protective casing (E).



IMPORTANT NOTES ON CABLES

To connect the speakers VERTUS CLA 403T and CLA 803T in an EVAC emergency evacuation system, use a CEI 20-105 approved cable. To install the speaker outdoors, it is STRICTLY NECESSARY to use a cable with overall diameter 6-9mm in order to guarantee the system's impermeability (CAUTION: tighten the cable gland properly).

To make a LINK, use a PG9 cable gland in a material with self-extinguishing rating 94V0 and protection rating IP68.

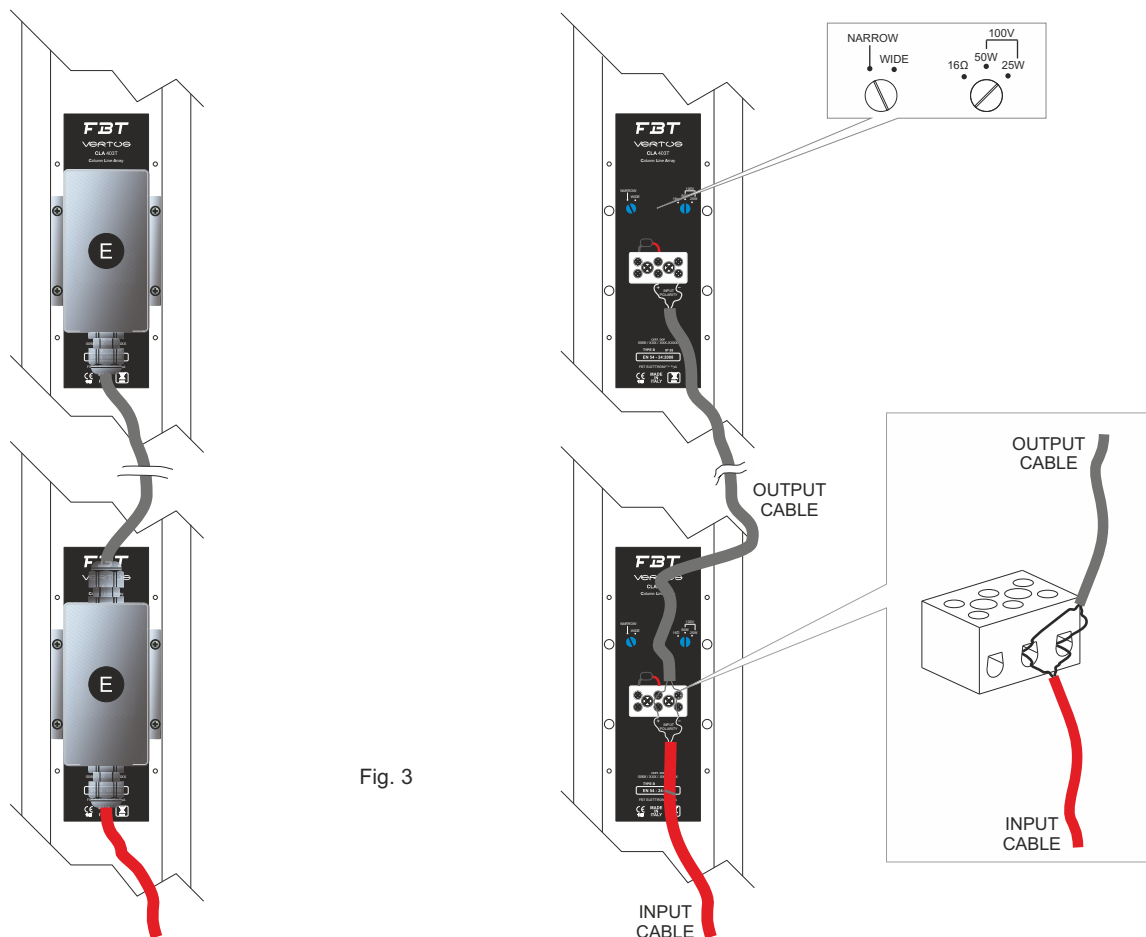

Fig. 3

CONNECTION MODES

SPEAKERS CONNECTION

Constant impedance speaker systems

Constant impedance outputs are generally used in the case of lines with a small number of speakers having a certain power and being placed at a minimum distance from the amplifier. Speaker connection will be a combination of connection in parallel and series connection, so to bring loudspeakers total impedance to a value which is not critical for the amplifier. In the series connection the positive lug shall be connected to the negative lug of the following speaker. In the connection with constant impedance it is always recommended that speakers total power is higher than the power supplied by the amplifier.

If in the connection with constant impedance the volume of one or more speakers needed to be set independently or also if any speaker needed to be switched off, the use of attenuators keeping impedance constant is required.

In the series connection, whatever the impedance of each speaker, the total impedance results from the sum of all the impedances. Anyway, using sound speakers with equal impedance and power is recommended.

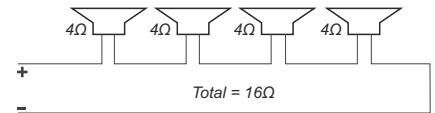

Series connection

The impedances are added up.

The 4 x 4Ω speakers can be connected to an amplifier that manages 16Ω connections.

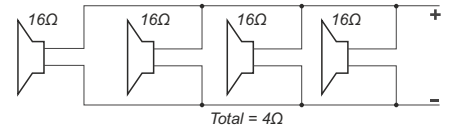

Parallel connection

The impedances are divided.

The 4 x 16Ω speakers can be connected to an amplifier that manages 4Ω connections.

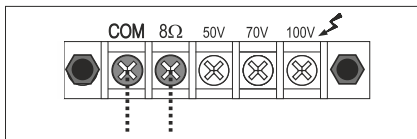

SPEAKERS CONNECTION

Constant voltage speaker systems

This connection system implies that each speaker is equipped with its own line transformer. The amplifier shall be equipped with 100V / 70V constant voltage outputs.

The loudspeakers connected in parallel to amplifier's output will make system expansion easier, if required, by simply shunting from any of the previously installed speakers. Similarly, the loudspeakers which are not necessary anymore can be removed. Matching the "phase" is necessary both in the connection of each speaker to its own transformer and in the connection in parallel of the speakers.

All the constant voltage outputs (100V/70V) of a single amplifier can be connected at the same time, provided that amplifier's rated power remains equal or higher to the sum of the power of all the speakers installed on each output line.

Using the following formula: $P=V^2/Z$ with V being 100V/70V and Z being speaker's transformer primary impedance any power applied to each speaker can be calculated. If, instead, you know the voltage (100V/70V) and the rated power (or powers) of the transformer and you want to calculate transformer impedance, the following formula applies: $Z=V^2/P$.

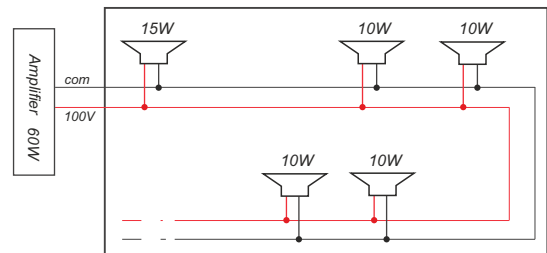
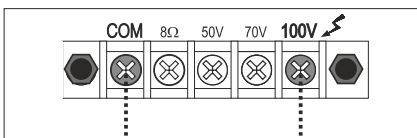

BEFORE 5 speakers were connected to the system for a total of 55W. The selected amplifier was 60W.

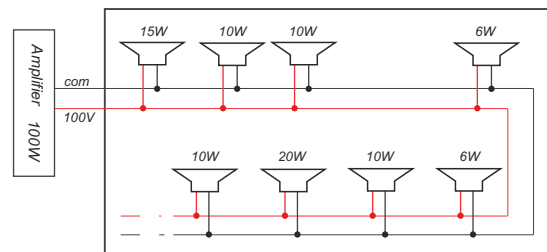

AFTER Speakers were added and removed from the system. The total requested power is now 87W. In this case it is sufficient to change the amplifier, but the system (in terms of cables) will remain unaltered.

TECHNICAL SPECIFICATIONS

	CLA 803T	CLA 403T
CONFIGURATION	1	1
RATED NOISE POWER (100 hrs)	100W / 28.2 Vrms	50W / 28.2 Vrms
RECOMMENDED AMPLIFIER	200 W RMS	100 W RMS
NOMINAL IMPEDANCE	8 Ohm	16 Ohm
NOMINAL IMPEDANCE (100V line)	200 Ohm / 100 W 400 Ohm / 50 W	85 Ohm / 50 W 166 Ohm / 25 W
SENSITIVITY	94 dB (@1W/1m)	91 dB (@1W/1m)
MAX. SOUND PRESSURE SPL	112 dB / 100 dB (@1m/4m)	106 dB / 94 dB (@1m/4m)
FREQUENCY RESPONSE	150 Hz - 20kHz (@ -6dB)	150 Hz - 20kHz (@ -6dB)
FULLRANGE DRIVER	8 x 3" / coil 0,75"	4 x 3" / coil 0,75"
HORIZONTAL DISPERSION (-6dB) Mode NARROW = WIDE	500Hz - 360° 1kHz - 170° 2kHz - 125° 4kHz - 125° 8kHz - 100°	500Hz - 360° 1kHz - 170° 2kHz - 125° 4kHz - 125° 8kHz - 100°
VERTICAL DISPERSION (-6dB) Mode WIDE	500Hz - 70° 1kHz - 35° 2kHz - 26° 4kHz - 26° 8kHz - 20°	500Hz - 160° 1kHz - 70° 2kHz - 36° 4kHz - 22° 8kHz - 20°
VERTICAL DISPERSION (-6dB) Mode NARROW	500Hz - 70° 1kHz - 35° 2kHz - 18° 4kHz - 10° 8kHz - 10°	500Hz - 160° 1kHz - 70° 2kHz - 28° 4kHz - 14° 8kHz - 9°
INPUT CONNECTOR	ceramic terminal block	ceramic terminal block
OPERATING / STORAGE TEMPERATURE	-25°C ÷ +55°C / -40°C ÷ +70°C	-25°C ÷ +55°C / -40°C ÷ +70°C
RELATIVE HUMIDITY	< 95%	< 95%
NET DIMENSIONS	3,93" x 27,69" x 4,92"	3,93" x 14,48" x 4,92"
TRANSPORT DIMENSIONS	6,29" x 29,92" x 7,08"	6,29" x 16,53" x 7,08"
NET WEIGHT	12,12 lb	6,61 lb
TRANSPORT WEIGHT	13,66 lb	7,71 lb

Acoustical measurement environment used for the specifications listed in this table are made in free field condition

It is recommended to use an external DSP processor (e.g. FBT DLM26) to improve system performance and reliability. The settings are available on the website www.fbt.it in the section dedicated to VERTUS CLA models.

Loudspeaker physical references

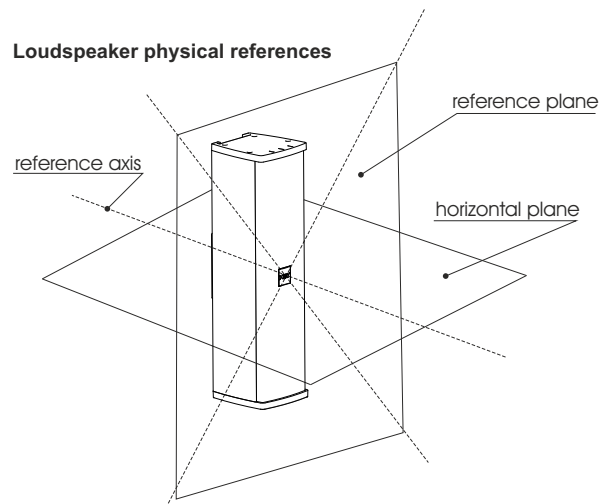

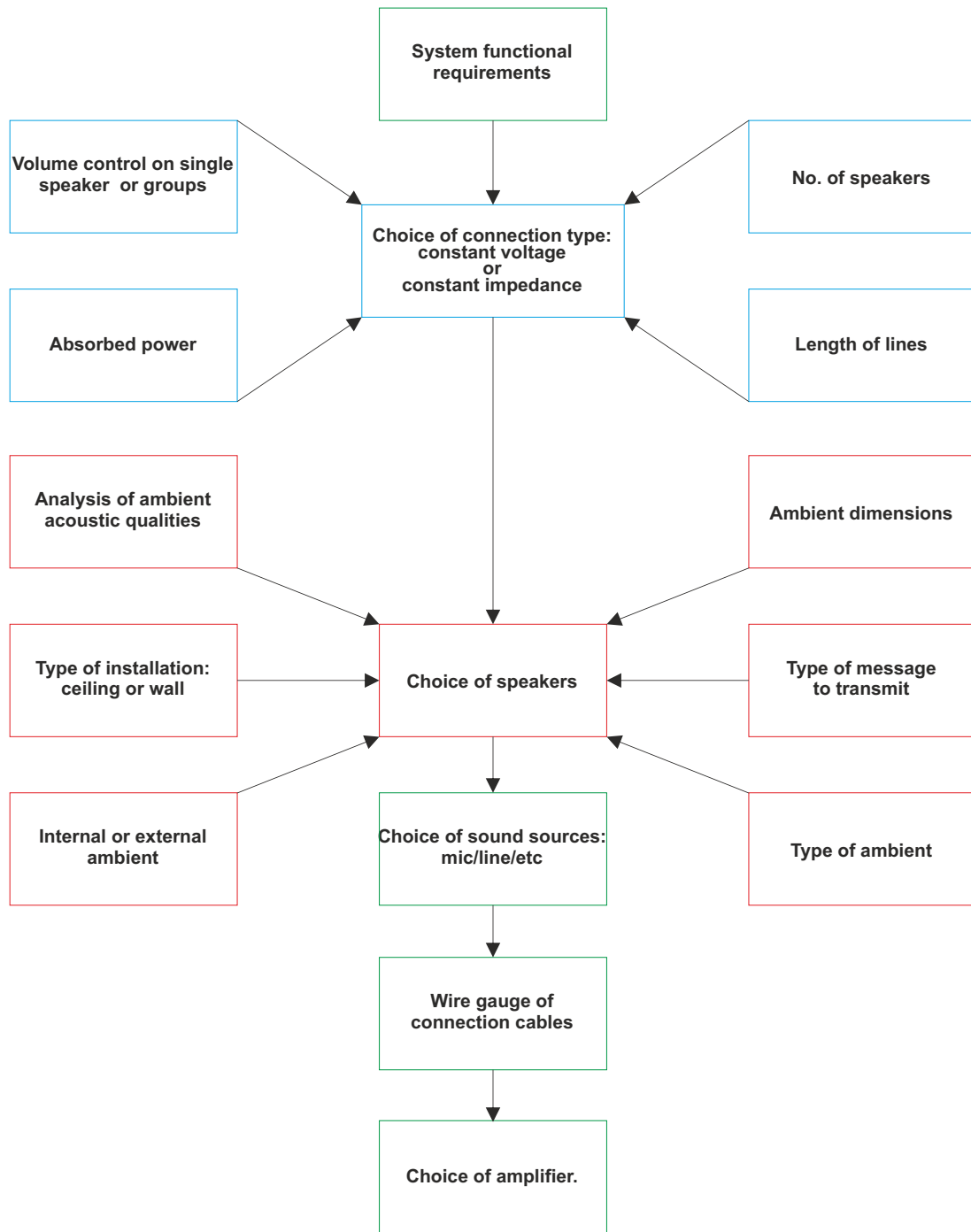



A series of horizontal dashed lines for writing, starting from the top of the page and extending downwards. The lines are evenly spaced and cover most of the page's width.



ATTENZIONE: il simbolo del cassonetto barrato, ove riportato sull'apparecchiatura o sulla confezione, indica che il prodotto alla fine della propria vita utile deve essere raccolto separatamente dagli altri rifiuti. Al termine dell'utilizzo, l'utente dovrà farsi carico di conferire il prodotto ad un idoneo centro di raccolta differenziata oppure di riconsegnarlo al rivenditore all'atto dell'acquisto di un nuovo prodotto. L'adeguata raccolta differenziata per l'avvio successivo dell'apparecchiatura dimessa al riciclaggio, al trattamento e allo smaltimento ambientalmente compatibile, contribuisce ad evitare possibili effetti negativi sull'ambiente e sulla salute e favorisce il reimpiego e/o riciclo dei materiali di cui è composta l'apparecchiatura. Lo smaltimento abusivo del prodotto da parte dell'utente comporta l'applicazione delle sanzioni amministrative previste ai sensi di legge.

WARNING: where affixed on the equipment or package, the barred waste bin sign indicates that the product must be separated from other waste at the end of its working life for disposal. At the end of use, the user must deliver the product to a suitable recycling centre or return it to the dealer when purchasing a new product. Adequate disposal of the decommissioned equipment for recycling, treatment and environmentally compatible disposal contributes in preventing potentially negative effects on the environment and health and promotes the reuse and/or recycling of equipment materials. Abusive product disposal by the user is punishable by law with administrative sanctions.

CODE 42973 08.09.2020 rev.02

Le informazioni contenute in questo manuale sono state scrupolosamente controllate; tuttavia la FBT non si assume nessuna responsabilità per eventuali inesattezze. La FBT Elettronica SpA si riserva il diritto di modificare le caratteristiche tecniche ed estetiche dei prodotti in qualsiasi momento e senza preavviso.

All informations included in this operating manual have been scrupulously controlled; however FBT is not responsible for eventual mistakes. FBT Elettronica SpA has the right to amend products and specifications without notice.
