

Precision coverage vertical active array

MAIN APPLICATIONS

Permanent installations in:

- Theatres, Concert Halls, Clubs, Places of Worship, Conference Rooms, Indoor Sports, Arenas & Stadiums
- Sound reinforcement for live events:
- Touring, Bands, Orchestras

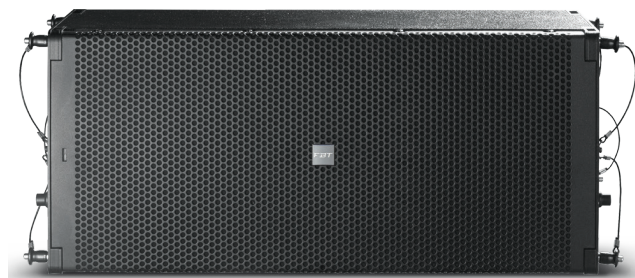

MAIN FEATURES

- Compact 2-way line array system in bass reflex
- Class D amplifiers, 800W RMS LF, 400W RMS HF with switching power supply
- 2 x 10" woofers with 2.5" coil
- 2 x custom B&C HF compression drivers with 1" throats
- DANTE audio streaming on board
- Remote control by INFINITO System Management Suite
- 90° horizontal waveguide up to 18kHz
- Control panel with: XLR « in&link », « in&out » RJ45 ethercon, oled display with encoder for control
- High SPL capability: 136dB
- Integrated rigging hardware
- Strong birch plywood cabinet
- Front led identification system
- Completely Manufactured in Italy

DESCRIPTION & TECHNICAL SPECIFICATIONS

A true line array system that includes advanced technology and refined engineering, these are the principles behind MUSE, a new sound reinforcement solution from FBT that redefines the modern line array in terms of power, size, light weight, flexibility and ease of use. The modularity of the FBT MUSE 210LND makes it extremely flexible for a wide range of applications, from a small two cabinets PA system to a complete line array system consisting of up to 16 FBT MUSE 210LND cabinets along with multiple FBT SUBLINE 218SND subs for large concert events. The system features 2 x 10" woofers with 2.5" voice coil and two custom B&C HF compression drivers with 1" throats. The system is powered from a 800W LF + 400W HF RMS amplifier in Class D technology. The summit of the entire project is the new amplification module with TCP/IP network interface; based on the OCA ALLIANCE AES70 standard it communicates with the "INFINITO System Management Suite" remote control software and receives 24 bit 48-96 kHz digital audio streaming from all devices compatible with the "DANTE" standard. The module is contained in an aluminum chassis with "intelligent" forced ventilation and is equipped with an OLED display with encoder for parameter setting, among which 8 presets offer simple configuration by adapting the DSP to the curvature of the array and the number of elements used. The waveguide, offers 90° horizontal dispersion; it allows the dispersion of a flat acoustic wave to over 18kHz, strictly respecting the most stringent physical criteria for an ideal cylindrical source; the acoustic configuration with the central horn allows symmetrical horizontal dispersion. The FBT MUSE 210LND hardware is internally integrated and allows the suspension of 16 arrays with a splay angle between 0° - 10° with 1° step. FBT MUSE 210LND is connected using the XLR input or via DANTE audio networking, using the RJ45 ethernet connectors and is equipped with a front LED that allows you to identify its position. FBT MUSE 210LND cabinets are constructed of a 0,59" (15mm) birch plywood, and incorporate two die cast aluminium handles; the front is protected by a heavy duty metal grille and cloth to protect the drivers. The FBT MUSE 210LND provides a wide range of hardware accessories for flying and ground stacked configurations. Universal 100-240 V main supply is through PowerCon. To extend the low frequencies, the MUSE system also includes two models of subwoofers: MUSE 118SND / MUSE 218SND.

Type	2 ways
Frequency response @-6dB	55Hz - 20kHz
Low frequency woofer	2 x 10" / 2,5" coil
High frequency woofer	2 x 1" / 1,7" coil
Crossover frequency	1.1kHz
SPL max. (cont / peak)	129dB / 136dB
Dispersion	90° x 10° (dependant upon n. of elements)
Built-in amplifiers LF/HF	max: 800W RMS / 4000W RMS peak: 1600W / 800W
Input impedance	22kOhm
Power supply inputs and re-links	PowerCon IN/OUT

Input connectors	XLR IN / OUT
Input / output NET	NET IN / NET OUT (EtherCon)
AC power consumption	600 W
Power cord	16,4ft / 5m
Material	wooden cabinet blackpolyurea finish
Handles	Integrated (1 x side)
Net size (WxHxD)	25.66" x 11.65" x 16.73" 652 x 296 x 515mm
Transport dimensions (WxHxD)	31.10" x 15.03" x 20.27" 790 x 382 x 515mm
Net weight	83.77 lbs / 38 kg
Shipping weight	91.49 lbs / 41.5 kg

HORIZONTAL POLAR DIAGRAMS

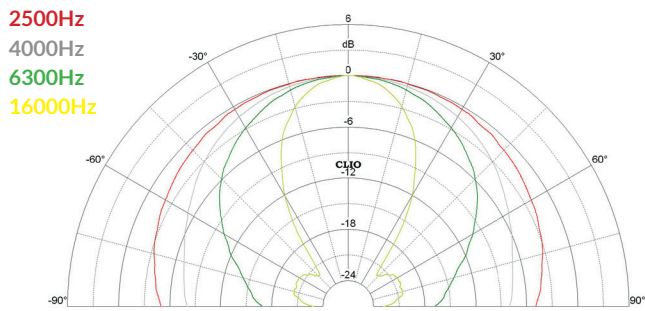
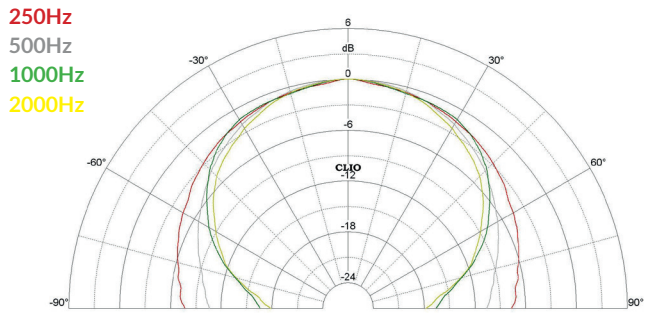

VERTICAL POLAR DIAGRAMS

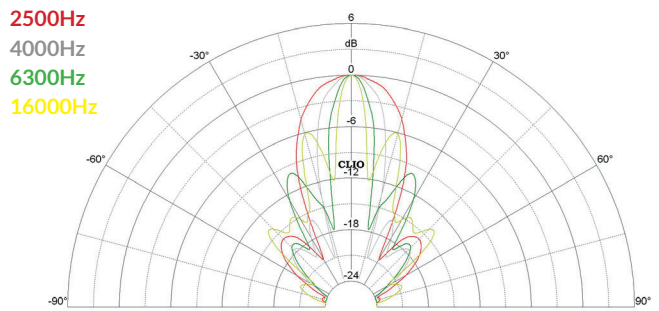
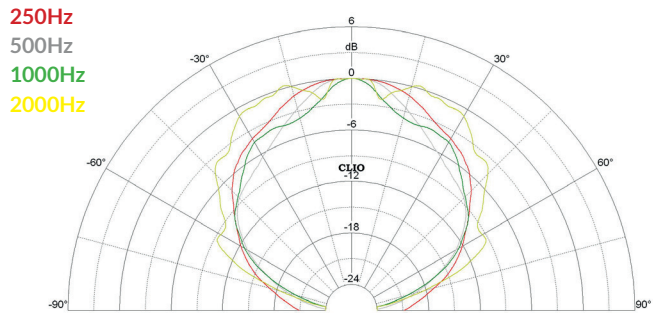

HORIZONTAL BEAMWIDTHTH

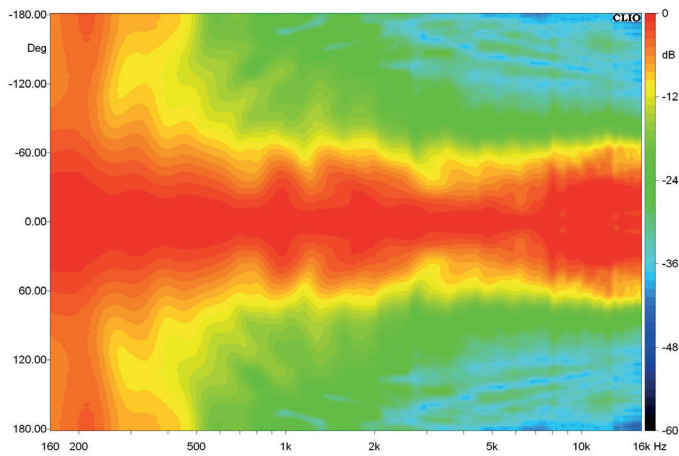

VERTICAL BEAMWIDTHTH

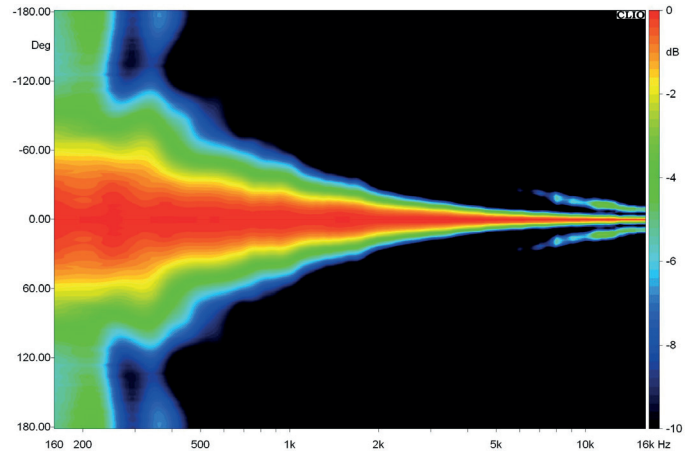

FREQUENCY RESPONSE

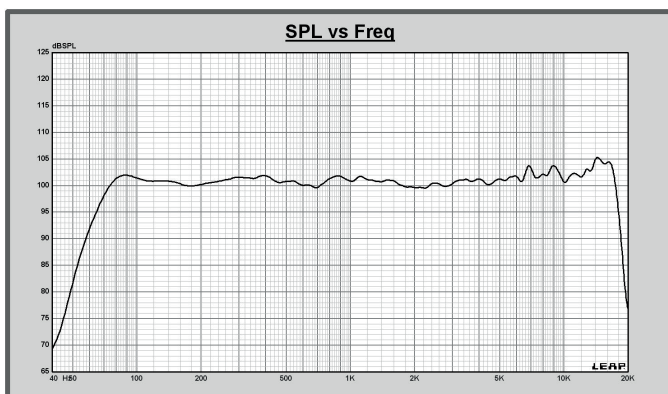

INFINITO



INFINITO is a real revolution in the FBT world that enhance the user experience in a new level of performance and simplicity! It's a software platform totally developed in house by FBT R&D team that offers real time monitoring of the internal sensors and status of connected devices, fast IN/OUT Vu-meters, controls of all the parameters, group management, warnings readout.

Download it from our website: www.fbt.it

CONNECTION PANEL

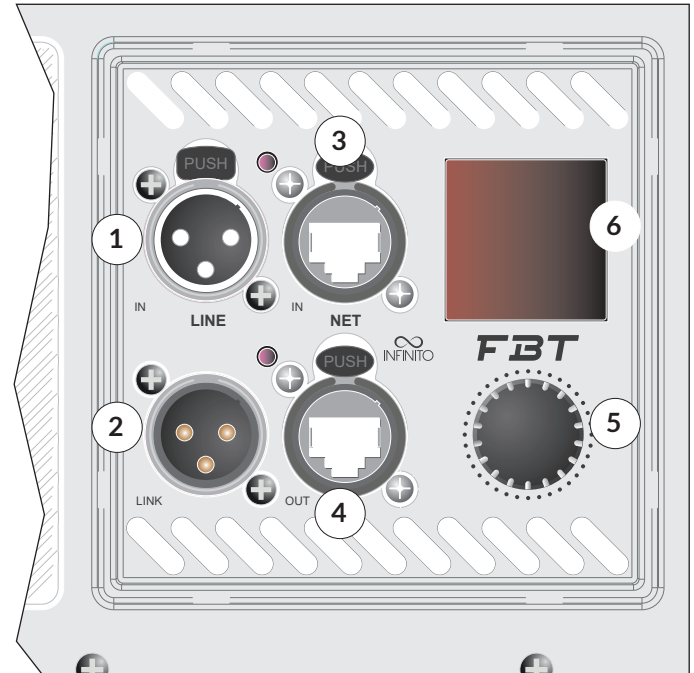
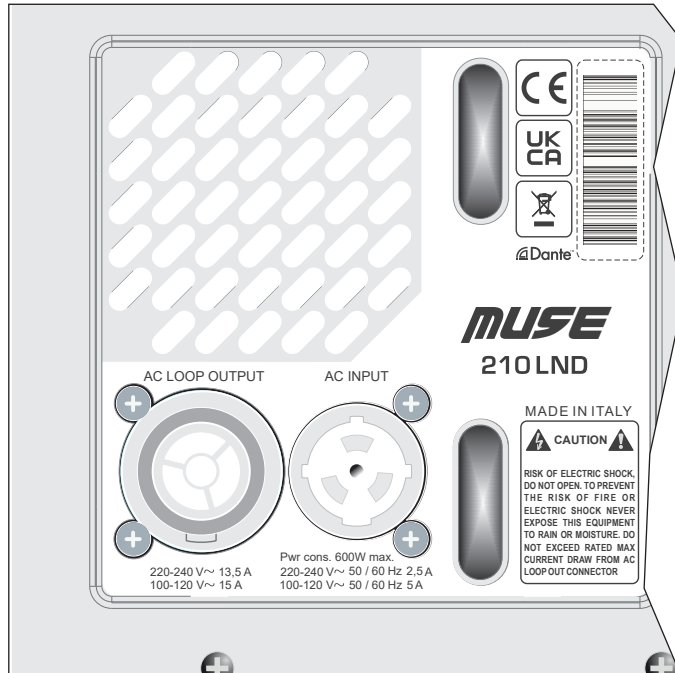

1. XLR input
2. Xlr link output
3. Port compatible with EtherCON/RJ45 connectors used for Ethernet network input for remote control and monitoring via INFINITO MANAGEMENT SOFTWARE

4. Port compatible with etherCON/RJ45 connectors used for the daisy chain output of the INFINITO SOFTWARE MANAGEMENT remote control and monitoring Ethernet network
5. General digital volume to control the level of signal. Press to enter the DSP menu and turn the knob to identify and select the parameters
6. Displaying of menus and DSP settings

DIMENSION DRAWING

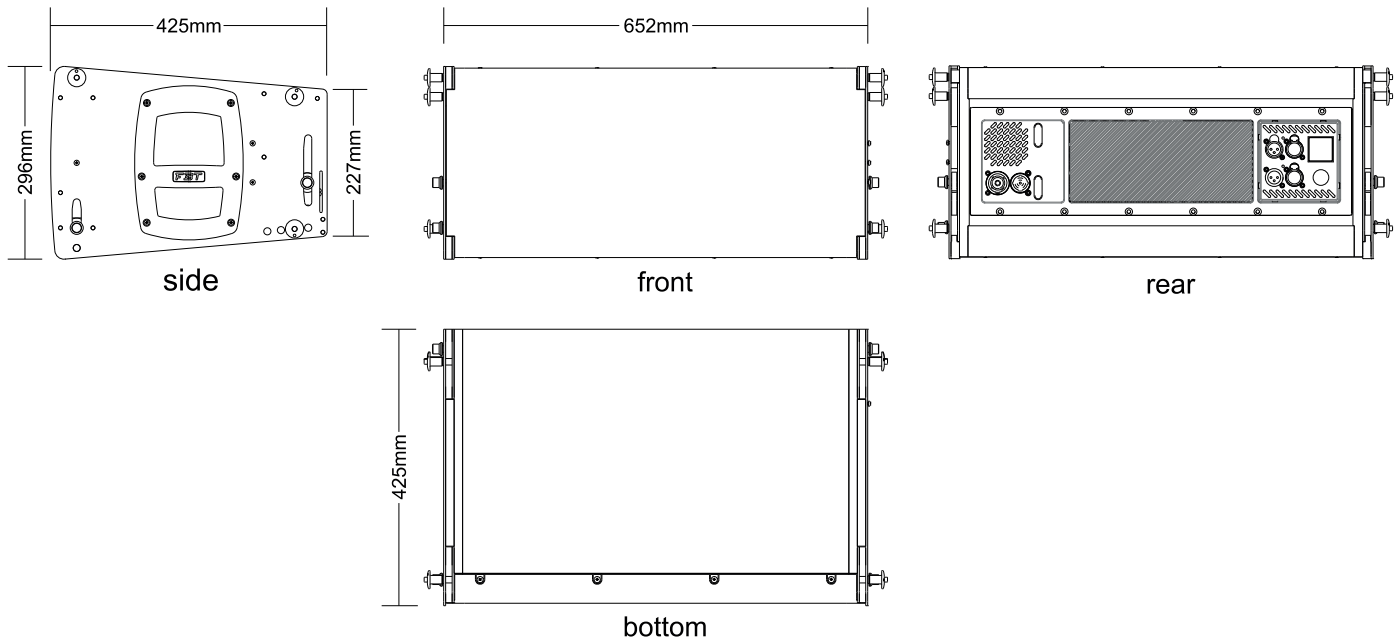

AMPLIFIER MODULE

The FBT MUSE 210LND provides a new 800+400W high-efficiency Class D power amplifier with network interface TCP/IP enclosed in a die-cast aluminium module with "intelligent" forced ventilation. This also allows to protect the electronics against dust and avoid any air loss.

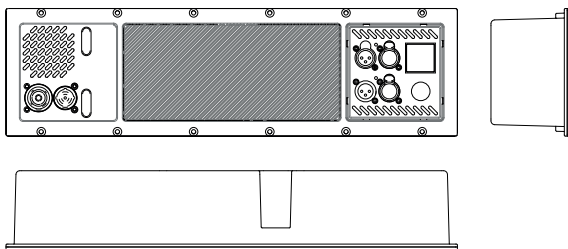

ACCESSORIES

MUSE models feature a suspension system embedded in the bearing structure. The only element to be added (accessories) to realize complete arrays is the flybar model MS F210; the suspension bar can also be used in a stacking configuration as ground support of the satellites above the subwoofer or as support of the system directly to earth.

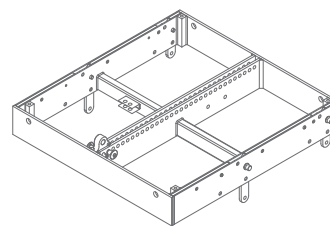

MS-F210
Flybar

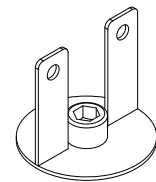

MS-J210
Support for ground-stacked
installation

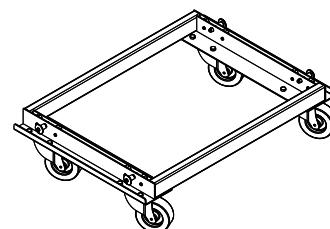

MS-T210
Cart for transporting
4 x MUSE 210LND

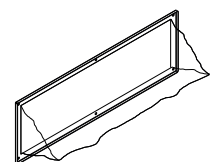

MS-C210
Rain cover