



# SHADOW

## 108CT

### APPLICATIONS

- Convention centers
- Athletic fields
- Stadiums
- Theme parks
- Swimming pools
- Cruise ships
- Malls
- Ballrooms
- Outdoor background music

### KEY FEATURES

- 2-way multipurpose 8" coax
- Sturdy molded polyethylene curved enclosure
- 8" coaxial woofer with 2" coil
- 1" HF driver with 1.4" coil
- Line transformer
- 4 wires cable to select the power tapping
- IP55 weather resistant
- Standard grey finish
- Completely manufactured in Italy

### ALL WEATHER LOUDSPEAKERS



Designed, Engineered  
and Manufactured in ITALY

### PRODUCT DESCRIPTION

The SHADOW 108CT is a weatherproof coaxial two way loudspeaker system offering substantial power and efficiency for a variety of professional indoor or outdoor applications. The low frequency transducer is a 8" woofer with a 2" voice coil. The high frequency section is a 1" driver with 1.4" voice coil on conical 90° horn. The SHADOW 108CT features a line transformer for 70-100V applications. The cabinet is a single piece rotational moulded in polyethylene, fully UV protected. The cabinet is equipped with a stainless steel U-bracket. The grille is in custom perforated stainless steel with 3 layers of protection. The SHADOW 108CT meets the requirements of IP55 code (International Protection

### ELECTRONIC SPECIFICATIONS

System Type	2 Way
Recommended Amplifier	450W RMS
System Long Term Power	225W
System Short Term Power (IEC 268-5)	900W
Transformer (optional)	100V / 100W/50W
Nominal Impedance	8 Ohm
Frequency Response	80Hz - 20kHz (@-6dB)
Sensitivity	95dB (@1W, 1m)
Max SPL (cont/peak) (bi-amp)*	120dB / 124dB
Dispersion	90° conical
Crossover Frequency	1.8kHz
Recommended HP Filter	60Hz - 24dB oct.

### PHYSICAL SPECIFICATIONS

Low Frequency Woofer	8" / 2" coil
High Frequency Driver	1" / 1.4" coil
Input Connectors	4 wire cable
Net Dimensions (WxHxD) inch	7.08 x 11.81 x 7.08
Shipping Dimensions (WxHxD) inch	11.22 x 11.22 x 9.84
Net Weight	15.4 lbs
Shipping Weight	19.8 lbs
Enclosure Material	Polyethylene rotomoulded
Grille	Custom perforated stainless steel

\* CONT. SPL: free space, based on recommended amp rating and LF transducer average sensitivity data, 125mS time average  
PEAK SPL: free space, based on short term applicable power rating and system peak sensitivity, 10mS time average



## DIAGRAMS

Horizontal polar diagram

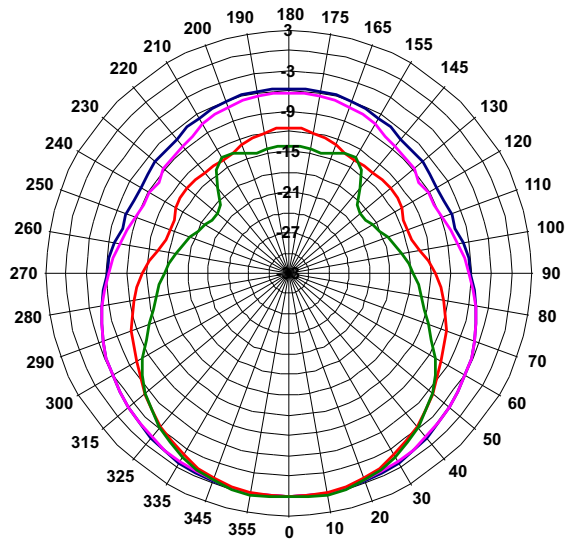
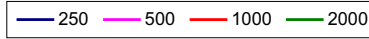

Horizontal polar diagram

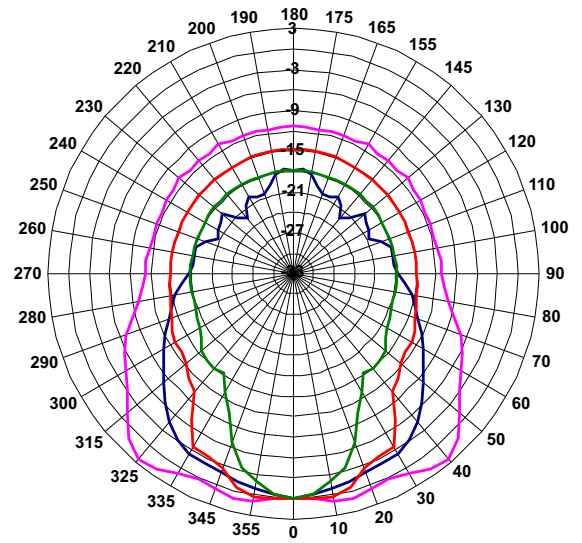

Horizontal coverage

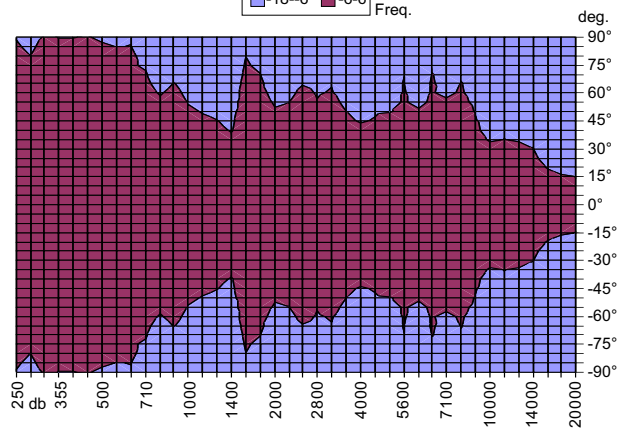



# SHADOW

## 108CT

### DIAGRAMS

Vertical polar diagram

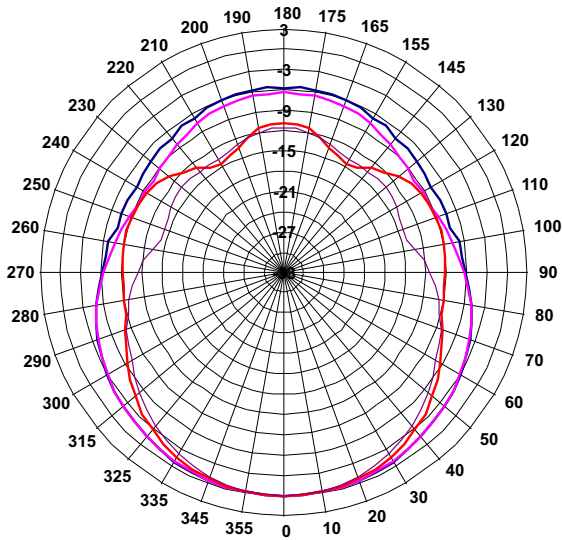
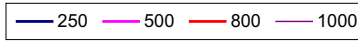

Vertical polar diagram

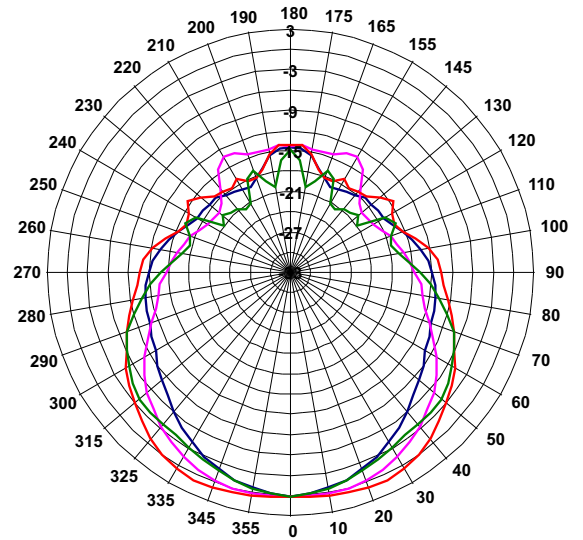
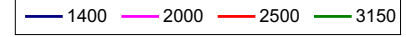

Vertical polar diagram

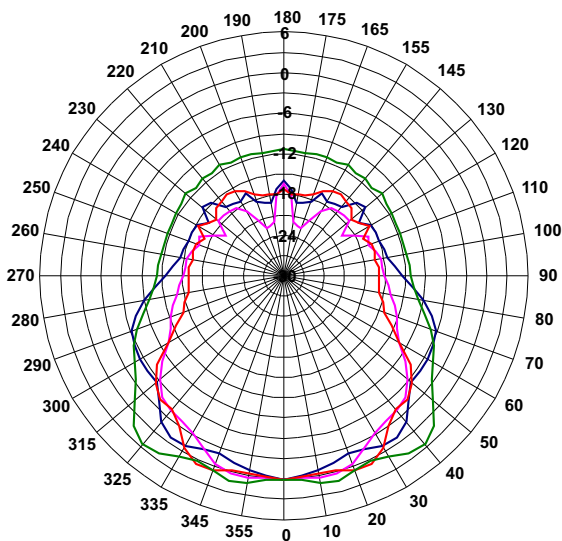
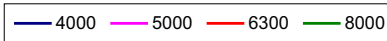

Vertical polar diagram

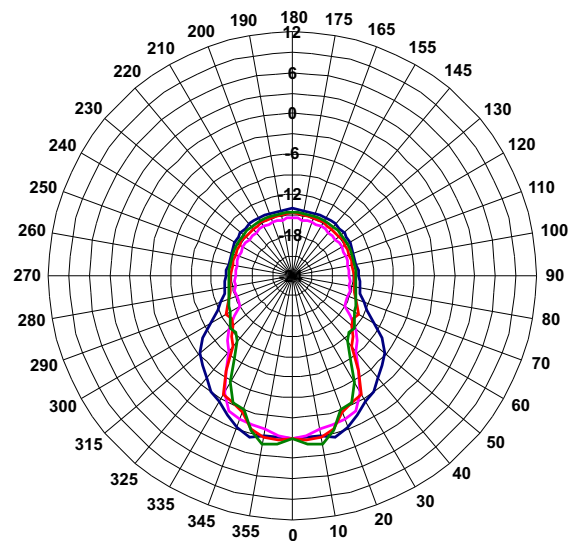
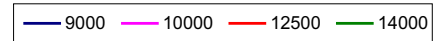

Vertical coverage

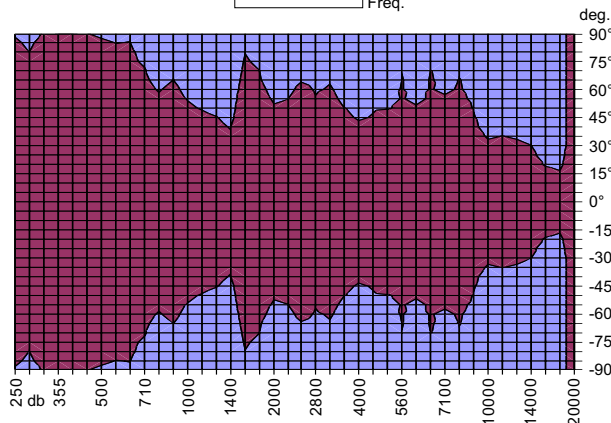



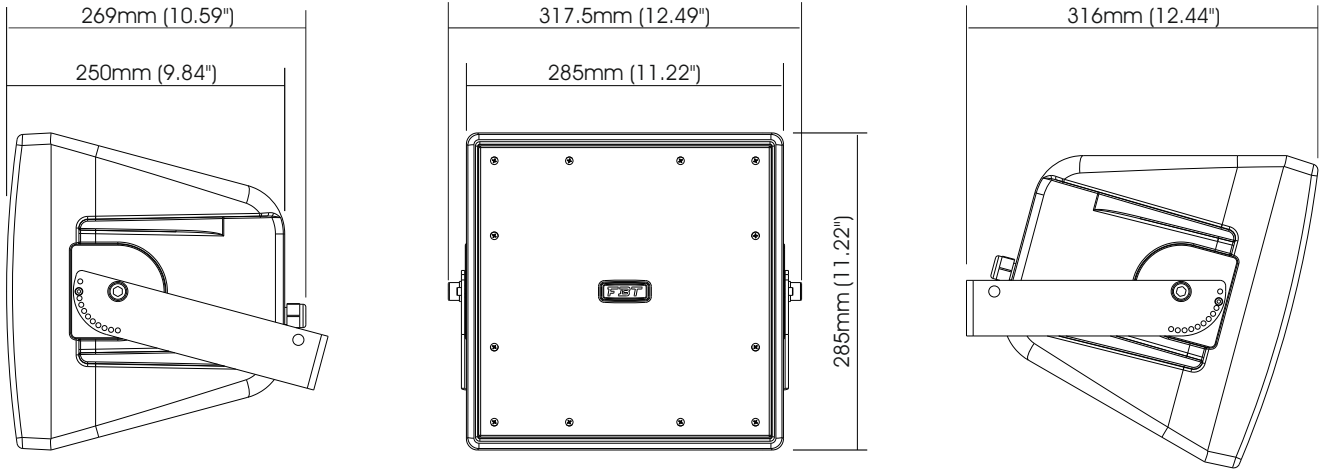

# SHADOW 108CT

## DIMENSIONAL DRAWINGS

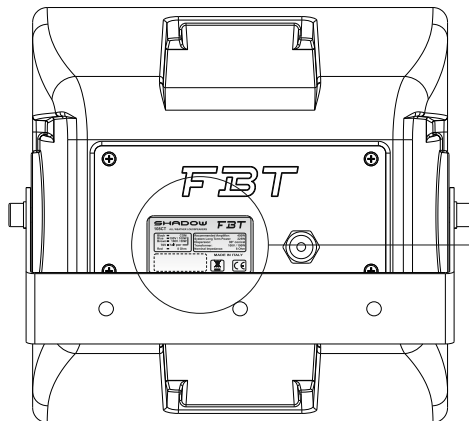

## TECHNICAL SPECIFICATIONS LABEL



<b>SHADOW FBT</b>	
108CT ALL WEATHER LOUDSPEAKERS	
Black - COM	Recommended Amplifier: 450W
Blue - 100V / 100W	System Long Term Power: 225W
Brown - 100V / 50W	Dispersion: 90° conical
70V = half pwr	Transformer: 100V / 100W
Red - 8 Ohm	Nominal Impedance: 8 Ohm
MADE IN ITALY	
 	

## SUPPLIED ACCESSORY

